

NÚMERO DE ESTRUCTURA	138	139	140	141	142	143	144	145	145	146	147	148	149	150	151	151	152	
ARMADO PRINCIPAL	SUSPENSION SIMPLE	SUSPENSION SIMPLE	SUSPENSION SIMPLE	SUSPENSION SIMPLE	SUSPENSION SIMPLE	SUSPENSION SIMPLE	SUSPENSION SIMPLE	RETENCION SIMF	TENCION SIMPLE	SUSPENSION SIMPLE	SUSPENSION SIMPLE	SUSPENSION SIMPLE	SUSPENSION SIMPLE	SUSPENSION SIMPLE	RA 0 A 30	RA 0 A 30	SUSPENSION SIM	
ACUMULADA (m)	12375.24	12469.07	12562.91	12656.75	12750.58	12844.42	12938.03	13031.68	13031.68	13126.68	13221.68	13316.68	13411.68	13506.68	13601.59	13601.59	13694.73	
VANO VIENTO (m)	93.84	93.84	93.84	93.84	93.84	93.72	93.63	94.32	94.32	95.00	95.00	95.00	95.00	94.95	94.02	94.02	93.41	
VANO PESO (m)	76.94	85.59	109.37	93.94	85.38	99.92	86.05	107.67	107.67	91.00	101.39	101.39	72.63	108.52	92.50	92.50	100.35	
SOPORTE	3(1x15/600/3)	ES(1x15/600/3)	ES(1x15/600/3)	ES(1x15/600/3)	ES(1x15/600/3)	ES(1x15/600/3)	ES(1x15/600/3)	ERRT(1x15/2700)	T(1x15/2700/3)	ES(1x15/600/3)	ES(1x15/600/3)	ES(1x15/600/3)	ES(1x15/600/3)	ES(1x15/600/3)	ERA-0-30(1x15/27	-30(1x15/2700/3)	ES(1x15/600/3)	
RETENIDAS																		
PUESTA A TIERRA	PAT-1C	PAT-1C	PAT-1C	PAT-1C	PAT-1C	PAT-1C	PAT-1C	PAT-1C	PAT-1C	PAT-1C	PAT-1C	PAT-1C	PAT-1C	PAT-1C	PAT-1C	PAT-1C	PAT-1C	
CIMENTACIÓN	3(1x15/600/3)	ES(1x15/600/3)	ES(1x15/600/3)	ES(1x15/600/3)	ES(1x15/600/3)	ES(1x15/600/3)	ES(1x15/600/3)	ERRT(1x15/2700)	T(1x15/2700/3)	ES(1x15/600/3)	ES(1x15/600/3)	ES(1x15/600/3)	ES(1x15/600/3)	ES(1x15/600/3)	ES(1x15/600/3)	ERA-0-30(1x15/27	-30(1x15/2700/3)	ES(1x15/600/3)
AMORTIGUADORES	-/-	-/-	-/-	-/-	-/-	-/-	-/-	-/-	-/-	-/-	-/-	-/-	-/-	-/-	-/-	-/-	-/-	-/-
AMORTIGUADORES-G	-/-	-/-	-/-	-/-	-/-	-/-	-/-	-/-	-/-	-/-	-/-	-/-	-/-	-/-	-/-	-/-	-/-	-/-
VANO HORIZONTAL (m)		93.84	93.84	93.84	93.84	93.84	93.84	93.61	93.65	95.00	95.00	95.00	95.00	94.99	94.91	94.91	93.14	
VANO REGULADOR (m)		93.77	93.77	93.77	93.77	93.77	93.77	93.77	93.77	94.99	94.99	94.99	94.99	94.99	94.99	94.99	93.77	
PARÁMETRO CATENARIA (m)		1518.17	1518.17	1518.17	1518.17	1518.17	1518.17	1518.17	1518.17	1518.17	1518.17	1518.17	1518.17	1518.17	1518.17	1518.17	1518.17	
PARÁM. CAT. - G (m)		2577.53	2577.53	2577.53	2577.53	2577.53	2577.53	2577.53	2577.53	2577.53	2577.53	2577.53	2577.53	2577.53	2577.53	2577.53	2577.53	
CONDUCTOR	1xIRAM 95/15 ACSR	1xIRAM 95/15 ACSR	1xIRAM 95/15 ACSR	1xIRAM 95/15 ACSR	1xIRAM 95/15 ACSR	1xIRAM 95/15 ACSR	1xIRAM 95/15 ACSR	1xIRAM 95/15 ACSR	1xIRAM 95/15 ACSR	1xIRAM 95/15 ACSR	1xIRAM 95/15 ACSR	1xIRAM 95/15 ACSR	1xIRAM 95/15 ACSR	1xIRAM 95/15 ACSR	1xIRAM 95/15 ACSR	1xIRAM 95/15 ACSR	1xIRAM 95/15 ACSR	
CONDUCTOR-G	1xHilo_Guarda_25/7	1xHilo_Guarda_25/7	1xHilo_Guarda_25/7	1xHilo_Guarda_25/7	1xHilo_Guarda_25/7	1xHilo_Guarda_25/7	1xHilo_Guarda_25/7	1xHilo_Guarda_25/7	1xHilo_Guarda_25/7	1xHilo_Guarda_25/7	1xHilo_Guarda_25/7	1xHilo_Guarda_25/7	1xHilo_Guarda_25/7	1xHilo_Guarda_25/7	1xHilo_Guarda_25/7	1xHilo_Guarda_25/7	1xHilo_Guarda_25/7	

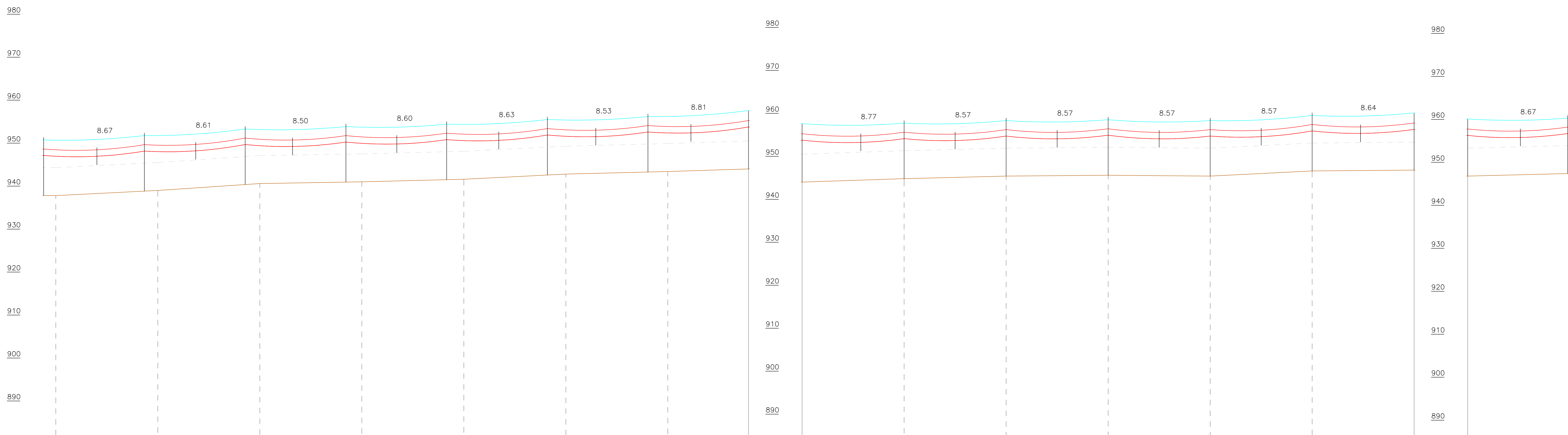

ESTACIÓN	-	95.00	-	95.00	12576.58	95.00	12671.58	95.00	12766.58	95.00	12861.58	95.00	12956.58	75.11	13031.68	13031.68	95.00	13126.68	95.00	13221.68	95.00	13316.68	95.00	13411.68	95.00	13506.68	94.91	13601.59	13601.59	95.00	13696.55
DISTANCIA PARCIAL (m)		95.00		95.00	95.00	95.00	95.00	95.00	95.00	95.00	95.00	95.00	95.00	75.11	95.00	95.00	95.00	95.00	95.00	95.00	95.00	95.00	95.00	95.00	95.00	95.00	94.91	95.00	95.00	95.00	
DISTANCIA ACUMULADA (m)	12386.58	12481.58	12576.58	12671.58	12766.58	12861.58	12956.58	13031.68	13031.68	13126.68	13221.68	13316.68	13411.68	13506.68	13601.59	13601.59	13696.55														
COTA DE TERRENO (m)	937.80	939.00	940.60	941.00	941.60	942.80	943.40	944.00	944.00	944.80	945.40	945.60	945.40	946.60	946.80	946.80	947.40														
TIPO DE TERRENO																															
PROPIETARIO																															

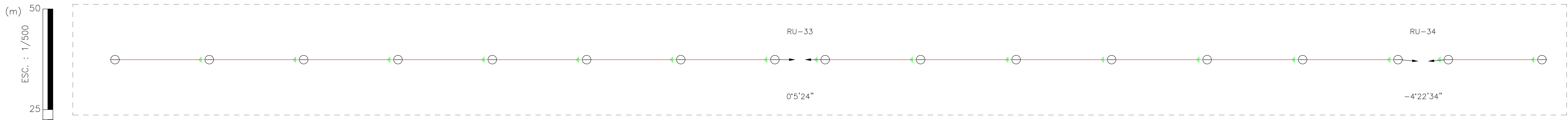

ESC. : 1/500

ESC. : 1/2000 (m)

2.11

REV.	DESCRIPCIÓN	DISEÑO	DIBUJO	APROBADO	FECHA

COMITENTE

GOBIERNO DE LA PROVINCIA DE SALTA
MINISTERIO DE INFRAESTRUCTURA.
GOBIERNO DE SALTA.

OBRA : "TENDIDO DE LINEA DE MEDIA TENSION EN 33 KV CON HILO DE GUARDIA DESDE EL PARQUE INDUSTRIAL Y HASTA LA ENTRADA AL ACCESO POR LA RUTA NAC.º9 A LA LOCALIDAD DEL LA CANDELARIA-EL JARDIN - EL TALA-E603021090356- DSC 0177/21-NIS537113.

RUTA

Distribución de Estructuras

PERFIL Y PLANIMETRIA : 12.38 km A 13.69 km

DIS. : Ing. MARIO ALFARO

REV. : -

APR. : -

DIB. : Arq. MARIEL ALFARO

DEPARTAMENTO: ROSARIO DE LA FRONTERA

PROVINCIA : SALTA

DISTRITO : METAN

FECHA :

ESCALA : H : 1/2000 V : 1/500

PLANO : 11/28

01-L.M.T.33 KV

NÚMERO DE ESTRUCTURA	152	153	154	155	156	157	158	159	160	161	162	163	164	165	166	167
ARMADO PRINCIPAL	PENSION SIMPLE	SUSPENSION SIMPLE	SUSPENSION SIMPLE	SUSPENSION SIMPLE	SUSPENSION SIMPLE	SUSPENSION SIMPLE	SUSPENSION SIMPLE	SUSPENSION SIMPLE	SUSPENSION SIMPLE	SUSPENSION SIMPLE	SUSPENSION SIMPLE	SUSPENSION SIMPLE	SUSPENSION SIMPLE	SUSPENSION SIMPLE	SUSPENSION SIMPLE	RETENCION SIMF
ACUMULADA (m)	13694.73	13788.40	13882.24	13976.07	14069.91	14163.75	14257.59	14351.42	14445.26	14539.10	14632.93	14726.77	14820.49	14914.11	15008.06	15101.67
VANO VIENTO (m)	93.41	93.75	93.84	93.84	93.84	93.84	93.84	93.84	93.84	93.84	93.84	93.78	93.67	93.78	93.78	90.64
VANO PESO (m)	100.35	69.25	105.16	100.45	88.28	102.17	83.08	92.61	65.74	123.21	104.40	108.16	48.57	115.10	89.00	126.33
SOPORTE	3(1x15/600/3)	ES(1x15/600/3)	ES(1x15/600/3)	ES(1x15/600/3)	ES(1x15/600/3)	ES(1x15/600/3)	ES(1x15/600/3)	ES(1x15/600/3)	ES(1x15/600/3)	ES(1x15/600/3)	ES(1x15/600/3)	ES(1x15/600/3)	ES(1x15/600/3)	ES(1x15/600/3)	ES(1x15/600/3)	ERRT(1x15/2700)
RETENIDAS																
PUESTA A TIERRA	PAT-1C	PAT-1C	PAT-1C	PAT-1C	PAT-1C	PAT-1C	PAT-1C	PAT-1C	PAT-1C	PAT-1C	PAT-1C	PAT-1C	PAT-1C	PAT-1C	PAT-1C	PAT-1C
CIMENTACIÓN	3(1x15/600/3)	ES(1x15/600/3)	ES(1x15/600/3)	ES(1x15/600/3)	ES(1x15/600/3)	ES(1x15/600/3)	ES(1x15/600/3)	ES(1x15/600/3)	ES(1x15/600/3)	ES(1x15/600/3)	ES(1x15/600/3)	ES(1x15/600/3)	ES(1x15/600/3)	ES(1x15/600/3)	ES(1x15/600/3)	ERRT(1x15/2700)
AMORTIGUADORES	-/-	-/-	-/-	-/-	-/-	-/-	-/-	-/-	-/-	-/-	-/-	-/-	-/-	-/-	-/-	-/-
AMORTIGUADORES-G	-/-	-/-	-/-	-/-	-/-	-/-	-/-	-/-	-/-	-/-	-/-	-/-	-/-	-/-	-/-	-/-
VANO HORIZONTAL (m)		93.67	93.84	93.84	93.84	93.84	93.84	93.84	93.84	93.84	93.84	93.84	93.72	93.62	93.94	93.61
VANO REGULADOR (m)		93.77	93.77	93.77	93.77	93.77	93.77	93.77	93.77	93.77	93.77	93.77	93.77	93.77	93.77	93.77
PARÁMETRO CATENARIA (m)		1518.17	1518.17	1518.17	1518.17	1518.17	1518.17	1518.17	1518.17	1518.17	1518.17	1518.17	1518.17	1518.17	1518.17	1518.17
PARÁM. CAT. - G (m)		2577.53	2577.53	2577.53	2577.53	2577.53	2577.53	2577.53	2577.53	2577.53	2577.53	2577.53	2577.53	2577.53	2577.53	2577.53
CONDUCTOR	1xIRAM 95/15 ACSR	1xIRAM 95/15 ACSR	1xIRAM 95/15 ACSR	1xIRAM 95/15 ACSR	1xIRAM 95/15 ACSR	1xIRAM 95/15 ACSR	1xIRAM 95/15 ACSR	1xIRAM 95/15 ACSR	1xIRAM 95/15 ACSR	1xIRAM 95/15 ACSR	1xIRAM 95/15 ACSR	1xIRAM 95/15 ACSR	1xIRAM 95/15 ACSR	1xIRAM 95/15 ACSR	1xIRAM 95/15 ACSR	1xIRAM 95/15 ACSR
CONDUCTOR-G	1xHilo_Guarda_25/7	1xHilo_Guarda_25/7	1xHilo_Guarda_25/7	1xHilo_Guarda_25/7	1xHilo_Guarda_25/7	1xHilo_Guarda_25/7	1xHilo_Guarda_25/7	1xHilo_Guarda_25/7	1xHilo_Guarda_25/7	1xHilo_Guarda_25/7	1xHilo_Guarda_25/7	1xHilo_Guarda_25/7	1xHilo_Guarda_25/7	1xHilo_Guarda_25/7	1xHilo_Guarda_25/7	1xHilo_Guarda_25/7

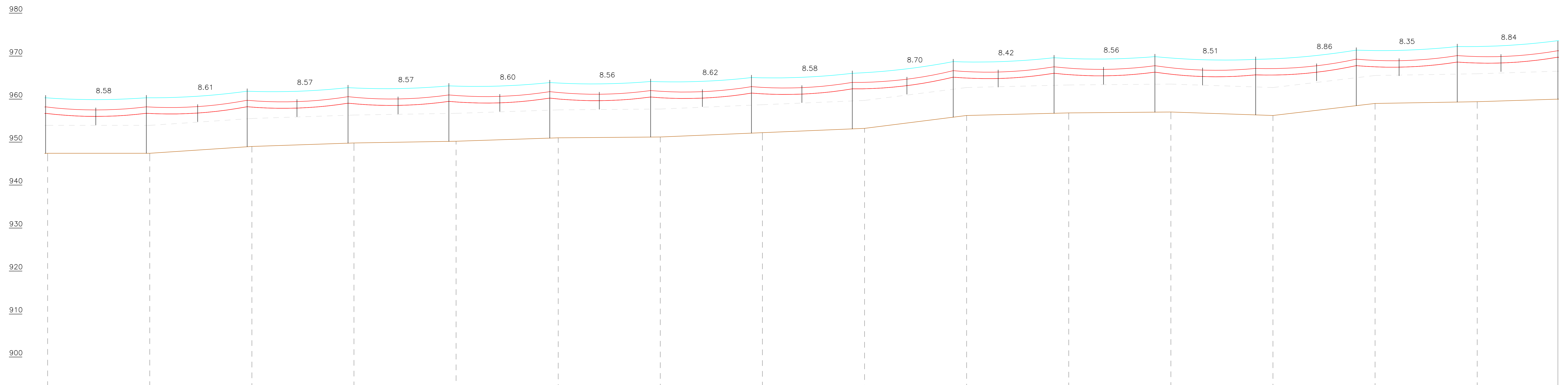

ESTACIÓN	-															RU-35
DISTANCIA PARCIAL (m)	95.00	95.00	95.00	95.00	95.00	95.00	95.00	95.00	95.00	95.00	95.00	95.00	95.00	95.00	95.00	75.08
DISTANCIA ACUMULADA (m)	13696.59	13791.59	13886.59	13981.59	14076.59	14171.59	14266.59	14361.59	14456.59	14551.59	14646.59	14741.59	14836.59	14931.59	15026.59	15101.67
COTA DE TERRENO (m)	947.40	947.40	949.00	949.80	950.20	951.00	951.20	952.20	953.20	956.20	956.80	957.00	956.20	959.00	959.40	960.00
TIPO DE TERRENO																
PROPIETARIO																

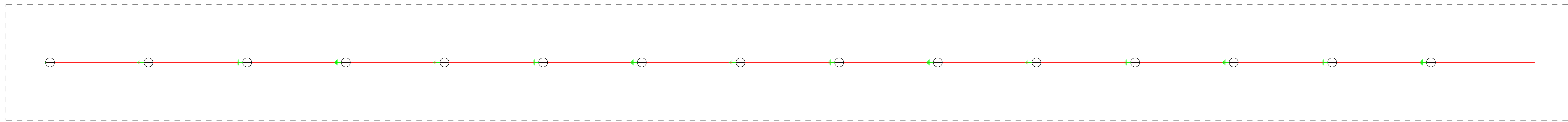
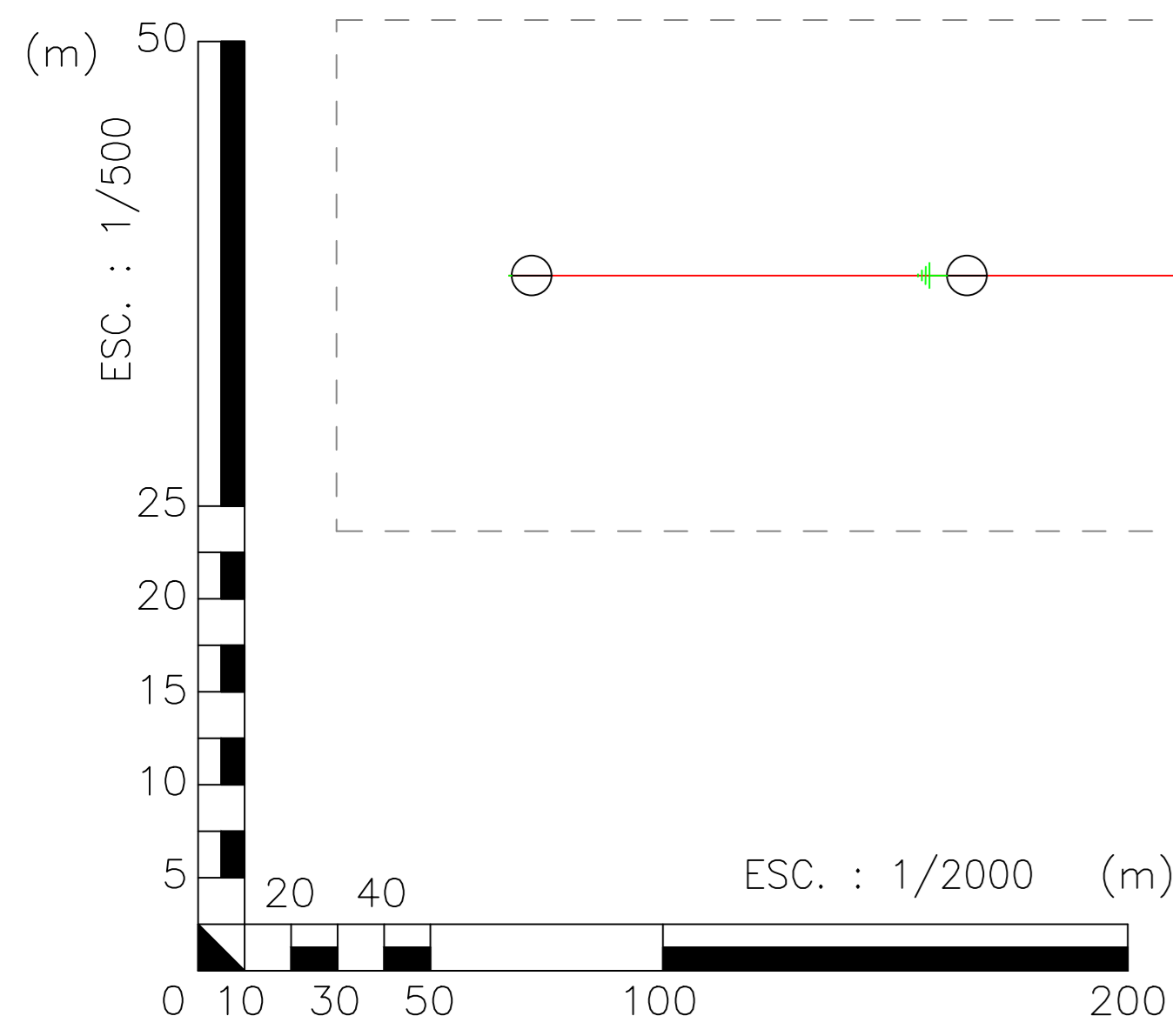

2.12					
REV.	DESCRIPCIÓN	DISEÑO	DIBUJO	APROBADO	FECHA

COMITENTE
 GOBIERNO DE LA PROVINCIA DE SALTA
 MINISTERIO DE INFRAESTRUCTURA.
 GOBIERNO DE SALTA.

OBRA: "TENDIDO DE LINEA DE MEDIA TENSION EN 33 KV CON HILO DE GUARDIA DESDE EL PARQUE INDUSTRIAL Y HASTA LA ENTRADA AL ACCESO POR LA RUTA NAC.º9 A LA LOCALIDAD DEL LA CANDELARIA-EL JARDIN - EL TALA-E603021090356- DSC 0177/21-NIS537113.

RUTA
 Distribución de Estructuras
 PERFIL Y PLANIMETRIA : 13.69 km A 15.10 km

DIS. : Ing. MARIO ALFARO
 REV. :-
 APR. :-
 DIB. : Arq. MARIEL ALFARO

DEPARTAMENTO: ROSARIO DE LA FRONTERA
 PROVINCIA : SALTA
 DISTRITO : METAN
 FECHA :
 ESCALA :
 H : 1/2000
 V : 1/500
 PLANO : 12/28
 01-L.M.T.33 KV

NÚMERO DE ESTRUCTURA	167	168	169	170	171	172	173	174	175	175	176	176	177	177	178	178	179	179	180
ARMADO PRINCIPAL	TENCION SIMPLE	SUSPENSION SIMPLE	SUSPENSION SIMPLE	SUSPENSION SIMPLE	SUSPENSION SIMPLE	SUSPENSION SIMPLE	SUSPENSION SIMPLE	SUSPENSION SIMPLE	RA O A 30	RA O A 30	RA O A 30	RA O A 30	RA O A 30	RA O A 30	RA O A 30	RA O A 30	RA O A 30	RA O A 30	RA O A 30
ACUMULADA (m)	15101.67	15189.34	15276.99	15364.63	15452.27	15539.61	15627.25	15714.89	15802.12	15802.12	15881.86	15881.86	15961.80	15961.80	16042.03	16042.03	16121.90	16121.90	16202.05
VANO VIENTO (m)	90.64	87.66	87.64	87.64	87.49	87.49	87.49	87.43	83.48	83.48	79.84	79.84	80.08	80.08	80.05	80.05	80.01	80.01	80.25
VANO PESO (m)	126.33	53.50	95.88	99.35	94.95	85.95	84.94	54.37	113.96	113.96	60.84	60.84	91.49	91.49	80.03	80.03	80.03	80.03	65.15
SOPORTE	T(1x15/2700/3)	ES(1x15/600/3)	ES(1x15/600/3)	ES(1x15/600/3)	ES(1x15/600/3)	ES(1x15/600/3)	ES(1x15/600/3)	ES(1x15/600/3)	ERA-0-30(1x15/2700)	0-30(1x15/2700/3)	ERA-0-30(1x15/2700)	0-30(1x15/2700/3)	ERA-0-30(1x15/2700)	0-30(1x15/2700/3)	ERA-0-30(1x15/2700)	0-30(1x15/2700/3)	ERA-0-30(1x15/2700)	0-30(1x15/2700/3)	ERA-0-30(1x15/2700)
RETENIDAS																			
PUESTA A TIERRA	PAT-1C	PAT-1C	PAT-1C	PAT-1C	PAT-1C	PAT-1C	PAT-1C	PAT-1C	PAT-1C	PAT-1C	PAT-1C	PAT-1C	PAT-1C	PAT-1C	PAT-1C	PAT-1C	PAT-1C	PAT-1C	PAT-1C
CIMENTACIÓN	T(1x15/2700/3)	ES(1x15/600/3)	ES(1x15/600/3)	ES(1x15/600/3)	ES(1x15/600/3)	ES(1x15/600/3)	ES(1x15/600/3)	ES(1x15/600/3)	ERA-0-30(1x15/2700)	0-30(1x15/2700/3)	ERA-0-30(1x15/2700)	0-30(1x15/2700/3)	ERA-0-30(1x15/2700)	0-30(1x15/2700/3)	ERA-0-30(1x15/2700)	0-30(1x15/2700/3)	ERA-0-30(1x15/2700)	0-30(1x15/2700/3)	ERA-0-30(1x15/2700)
AMORTIGUADORES	-/-	-/-	-/-	-/-	-/-	-/-	-/-	-/-	-/-	-/-	-/-	-/-	-/-	-/-	-/-	-/-	-/-	-/-	-/-
AMORTIGUADORES-G	-/-	-/-	-/-	-/-	-/-	-/-	-/-	-/-	-/-	-/-	-/-	-/-	-/-	-/-	-/-	-/-	-/-	-/-	-/-
VANO HORIZONTAL (m)		87.68	87.64	87.64	87.64	87.34	87.64	87.64	87.23		79.74		79.94		80.23		79.87		80.16
VANO REGULADOR (m)		87.56	87.56	87.56	87.56	87.56	87.56	87.56	87.56		79.74		79.94		80.23		79.87		80.16
PARÁMETRO CATENARIA (m)		1518.17	1518.17	1518.17	1518.17	1518.17	1518.17	1518.17	1518.17		1518.17		1518.17		1518.17		1518.17		1518.17
PARÁM. CAT. - G (m)		2577.53	2577.53	2577.53	2577.53	2577.53	2577.53	2577.53	2577.53		2577.53		2577.53		2577.53		2577.53		2577.53
CONDUCTOR	1xIRAM 95/15 ACSR	1xIRAM 95/15 ACSR	1xIRAM 95/15 ACSR	1xIRAM 95/15 ACSR	1xIRAM 95/15 ACSR	1xIRAM 95/15 ACSR	1xIRAM 95/15 ACSR	1xIRAM 95/15 ACSR	1xIRAM 95/15 ACSR		1xIRAM 95/15 ACSR		1xIRAM 95/15 ACSR		1xIRAM 95/15 ACSR		1xIRAM 95/15 ACSR		1xIRAM 95/15 ACSR
CONDUCTOR-G	1xHilo_Guarda_25/7	1xHilo_Guarda_25/7	1xHilo_Guarda_25/7	1xHilo_Guarda_25/7	1xHilo_Guarda_25/7	1xHilo_Guarda_25/7	1xHilo_Guarda_25/7	1xHilo_Guarda_25/7	1xHilo_Guarda_25/7		1xHilo_Guarda_25/7		1xHilo_Guarda_25/7		1xHilo_Guarda_25/7		1xHilo_Guarda_25/7		1xHilo_Guarda_25/7

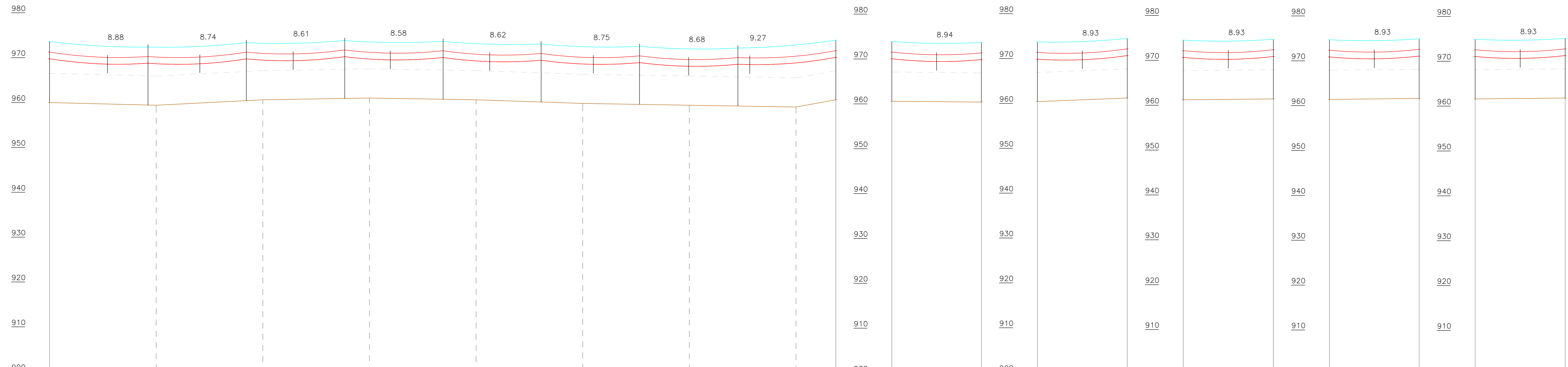

ESTACIÓN	RU-35										RU-36	RU-36	RU-37	RU-37	RU-38	RU-38	RU-39	RU-39	RU-40	RU-40	RU-41
DISTANCIA PARCIAL (m)	95.00	95.00	95.00	95.00	95.00	95.00	95.00	95.00	95.00	35.45	45	79.74	79.74	79.94	79.94	80.23	80.23	79.87	80.16	80.16	80.25
DISTANCIA ACUMULADA (m)	15101.67	15196.67	15291.67	15386.67	15481.67	15576.67	15671.67	15766.67	15802.12	15802.12	15881.86	15881.86	15961.80	15961.80	16042.03	16042.03	16121.90	16121.90	16202.05	16202.05	16202.05
COTA DE TERRENO (m)	960.00	959.40	960.60	961.00	960.60	959.80	959.40	959.00	960.60	960.60	960.40	960.40	961.20	961.20	961.40	961.40	961.60	961.60	961.80	961.80	961.80
TIPO DE TERRENO																					
PROPIETARIO																					

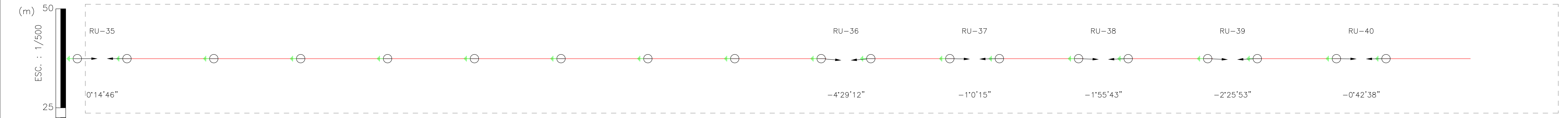

2.13				COMITENTE GOBIERNO DE LA PROVINCIA DE SALTA MINISTERIO DE INFRAESTRUCTURA. GOBIERNO DE SALTA.		OBRA : "TENDIDO DE LINEA DE MEDIA TENSION EN 33 KV CON HILO DE GUARDIA DESDE EL PARQUE INDUSTRIAL Y HASTA LA ENTRADA AL ACCESO POR LA RUTA NAC.º9 A LA LOCALIDAD DEL LA CANDELARIA-EL JARDIN - EL TALA-E603021090356- DSC 0177/21-NIS537113.		DIS. : Ing. MARIO ALFARO REV. :- APR. :- DIB. : Arq. MARIEL ALFARO		DEPARTAMENTO: ROSARIO DE LA FRONTERA PROVINCIA : SALTA DISTRITO : METAN FECHA :		ESCALA : H : 1/2000 V : 1/500		PLANO : 13/28 01-L.M.T.33 KV	
REV.	DESCRIPCIÓN	DISÑO	DIBUJO	APROBADO	FECHA	RUTA Distribución de Estructuras PERFIL Y PLANIMETRIA : 15.10 km A 16.20 km									

NÚMERO DE ESTRUCTURA	180	181	181	182	182	183	183	184	184	185	186	187	188	189	190	191	192	193
ARMADO PRINCIPAL	RA 0 A 30	RA 0 A 30	RA 0 A 30	RA 0 A 30	RA 0 A 30	RA 0 A 30	RA 0 A 30	RA 0 A 30	RA 0 A 30	SUSPENSION SIMPLE	SUSPENSION SIMPLE	SUSPENSION SIMPLE	SUSPENSION SIMPLE	SUSPENSION SIMPLE	SUSPENSION SIMPLE	SUSPENSION SIMPLE	SUSPENSION SIMPLE	SUSPENSION SIM
ACUMULADA (m)	16202.05	16282.40	16282.40	16362.38	16362.38	16442.03	16442.03	16521.59	16521.59	16614.78	16708.64	16802.50	16896.36	16990.22	17084.08	17177.94	17271.79	17365.65
VANO VIENTO (m)	80.25	80.16	80.16	79.81	79.81	79.61	79.61	86.37	86.37	93.53	93.86	93.86	93.86	93.86	93.86	94.51	93.86	93.94
VANO PESO (m)	65.15	140.81	140.81	38.06	38.06	49.08	49.08	119.35	119.35	109.88	72.56	111.49	79.61	101.90	94.51	76.45	83.51	76.00
SOPORTE	-0-30(1x15/2700/3)	ERA-0-30(1x15/2700/3)	-0-30(1x15/2700/3)	ERA-0-30(1x15/2700/3)	-0-30(1x15/2700/3)	ERA-0-30(1x15/2700/3)	-0-30(1x15/2700/3)	ERA-0-30(1x15/2700/3)	-0-30(1x15/2700/3)	ES(1x15/600/3)	ES(1x15/600/3)	ES(1x15/600/3)	ES(1x15/600/3)	ES(1x15/600/3)	ES(1x15/600/3)	ES(1x15/600/3)	ES(1x15/600/3)	ES(1x15/600/3)
RETENIDAS																		
PUESTA A TIERRA	PAT-1C	PAT-1C	PAT-1C	PAT-1C	PAT-1C	PAT-1C	PAT-1C	PAT-1C	PAT-1C	PAT-1C	PAT-1C	PAT-1C	PAT-1C	PAT-1C	PAT-1C	PAT-1C	PAT-1C	PAT-1C
CIMENTACIÓN	-0-30(1x15/2700/3)	ERA-0-30(1x15/2700/3)	-0-30(1x15/2700/3)	ERA-0-30(1x15/2700/3)	-0-30(1x15/2700/3)	ERA-0-30(1x15/2700/3)	-0-30(1x15/2700/3)	ERA-0-30(1x15/2700/3)	-0-30(1x15/2700/3)	ES(1x15/600/3)	ES(1x15/600/3)	ES(1x15/600/3)	ES(1x15/600/3)	ES(1x15/600/3)	ES(1x15/600/3)	ES(1x15/600/3)	ES(1x15/600/3)	ES(1x15/600/3)
AMORTIGUADORES	-/-	-/-	-/-	-/-	-/-	-/-	-/-	-/-	-/-	-/-	-/-	-/-	-/-	-/-	-/-	-/-	-/-	-/-
AMORTIGUADORES-G	-/-	-/-	-/-	-/-	-/-	-/-	-/-	-/-	-/-	-/-	-/-	-/-	-/-	-/-	-/-	-/-	-/-	-/-
VANO HORIZONTAL (m)		80.35		79.97		79.66		79.55		93.19		93.86		93.86		93.86		93.86
VANO REGULADOR (m)		80.35		79.97		79.66		79.55		93.83		93.83		93.83		93.83		93.83
PARÁMETRO CATENARIA (m)		1518.17		1518.17		1518.17		1518.17		1518.17		1518.17		1518.17		1518.17		1518.17
PARÁM. CAT. - G (m)		2577.53		2577.53		2577.53		2577.53		2577.53		2577.53		2577.53		2577.53		2577.53
CONDUCTOR	1xIRAM 95/15 ACSR	1xIRAM 95/15 ACSR	1xIRAM 95/15 ACSR	1xIRAM 95/15 ACSR	1xIRAM 95/15 ACSR	1xIRAM 95/15 ACSR	1xIRAM 95/15 ACSR	1xIRAM 95/15 ACSR	1xIRAM 95/15 ACSR	1xIRAM 95/15 ACSR	1xIRAM 95/15 ACSR	1xIRAM 95/15 ACSR	1xIRAM 95/15 ACSR	1xIRAM 95/15 ACSR	1xIRAM 95/15 ACSR	1xIRAM 95/15 ACSR	1xIRAM 95/15 ACSR	1xIRAM 95/15 ACSR
CONDUCTOR-G	1xHilo_Guarda_25/7	1xHilo_Guarda_25/7	1xHilo_Guarda_25/7	1xHilo_Guarda_25/7	1xHilo_Guarda_25/7	1xHilo_Guarda_25/7	1xHilo_Guarda_25/7	1xHilo_Guarda_25/7	1xHilo_Guarda_25/7	1xHilo_Guarda_25/7	1xHilo_Guarda_25/7	1xHilo_Guarda_25/7	1xHilo_Guarda_25/7	1xHilo_Guarda_25/7	1xHilo_Guarda_25/7	1xHilo_Guarda_25/7	1xHilo_Guarda_25/7	1xHilo_Guarda_25/7

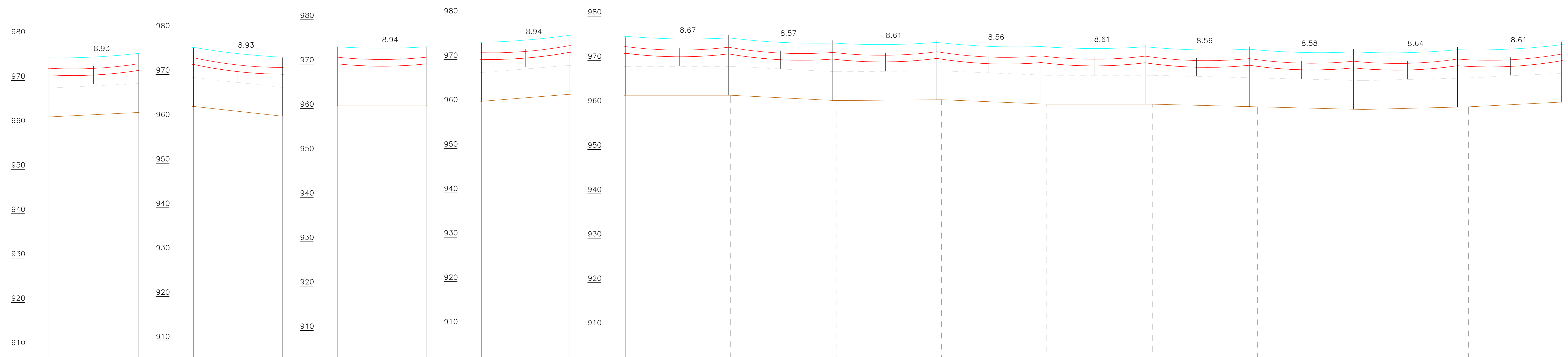

ESTACIÓN	RU-41	RU-42	RU-42	RU-43	RU-43	RU-44	RU-44	RU-45	RU-45	-	-	-	-	-	-	-	-	-													
DISTANCIA PARCIAL (m)	80.35	16282.40	16282.40	79.97	16362.38	16362.38	79.66	16442.03	16442.03	79.55	16521.59	16521.59	95.00	16616.59	95.00	16711.59	95.00	16806.59	95.00	16901.59	95.00	16996.59	95.00	17091.59	95.00	17186.59	95.00	17281.59	95.00	17376	
DISTANCIA ACUMULADA (m)	16202.05	16282.40	16282.40	16362.38	16362.38	16442.03	16442.03	16521.59	16521.59	16614.78	16708.64	16802.50	16896.36	16990.22	17084.08	17177.94	17271.79	17365.65	17459.51	17553.37	17647.23	17741.09	17834.95	17928.81	18022.67	18116.53	18210.39	18304.25	18398.11	18491.97	
COTA DE TERRENO (m)	961.80	962.80	962.80	960.60	960.60	960.60	960.60	962.20	962.20	962.20	962.20	962.20	961.00	961.00	961.00	961.00	961.00	961.00	961.00	961.00	961.00	961.00	961.00	961.00	961.00	961.00	961.00	961.00	961.00	961.00	
TIPO DE TERRENO																															
PROPIETARIO																															

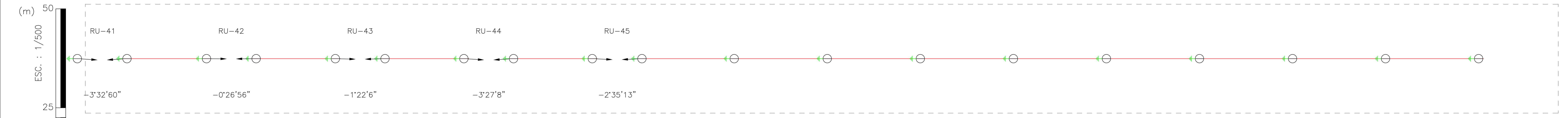

<p>2.14</p>		<p>COMITENTE</p> <p>GOBIERNO DE LA PROVINCIA DE SALTA MINISTERIO DE INFRAESTRUCTURA. GOBIERNO DE SALTA.</p>		<p>OBRA : "TENDIDO DE LINEA DE MEDIA TENSION EN 33 KV CON HILO DE GUARDIA DESDE EL PARQUE INDUSTRIAL Y HASTA LA ENTRADA AL ACCESO POR LA RUTA NAC.º9 A LA LOCALIDAD DEL LA CANDELARIA-EL JARDIN - EL TALA-E603021090356- DSC 0177/21-NIS537113.</p>		<p>DIS. : Ing. MARIO ALFARO</p> <p>REV. :-</p>		<p>DEPARTAMENTO: ROSARIO DE LA FRONTERA</p> <p>PROVINCIA : SALTA</p> <p>DISTRITO : METAN</p> <p>FECHA :</p>											
<p>REV.</p>		<p>DESCRIPCIÓN</p>		<p>DISEÑO</p>		<p>DIBUJO</p>		<p>APROBADO</p>		<p>FECHA</p>		<p>RUTA</p> <p>Distribución de Estructuras</p> <p>PERFIL Y PLANIMETRÍA : 16.20 km A 17.37 km</p>		<p>APR. :-</p> <p>DIB. : Arq. MARIEL ALFARO</p>		<p>ESCALA :</p> <p>H : 1/2000</p> <p>V : 1/500</p>		<p>PLANO : 14/28</p> <p>01-L.M.T.33 KV</p>	

NÚMERO DE ESTRUCTURA	193	194	195	196	197	198	199	200	200	201	202	203	204	205	206	207
ARMADO PRINCIPAL	PENSION SIMPLE	SUSPENSION SIMPLE	SUSPENSION SIMPLE	SUSPENSION SIMPLE	SUSPENSION SIMPLE	SUSPENSION SIMPLE	SUSPENSION SIMPLE	RETENCION SIMF	TENCION SIMPLE	SUSPENSION SIMPLE	SUSPENSION SIMPLE	SUSPENSION SIMPLE	SUSPENSION SIMPLE	SUSPENSION SIMPLE	SUSPENSION SIMPLE	SUSPENSION SIM
ACUMULADA (m)	17365.65	17459.68	17553.54	17647.40	17741.22	17835.06	17928.45	18022.06	18022.06	18115.22	18208.83	18302.67	18396.51	18490.34	18584.18	18678.02
VANO VIENTO (m)	93.94	93.94	93.86	93.84	93.83	93.61	93.50	93.39	93.39	93.38	93.72	93.84	93.84	93.84	93.84	93.84
VANO PESO (m)	76.00	66.62	62.74	146.30	168.11	71.98	4.96	162.74	162.74	123.64	38.94	113.18	82.86	131.65	108.52	68.92
SOPORTE	S(1x15/600/3)	ES(1x15/600/3)	ES(1x15/600/3)	ES(1x15/600/3)	ES(1x15/600/3)	ES(1x15/600/3)	ES(1x15/600/3)	ERRT(1x15/2700)	T(1x15/2700/3)	ES(1x15/600/3)	ES(1x15/600/3)	ES(1x15/600/3)	ES(1x15/600/3)	ES(1x15/600/3)	ES(1x15/600/3)	ES(1x15/600/3)
RETENIDAS																
PUESTA A TIERRA	PAT-1C	PAT-1C	PAT-1C	PAT-1C	PAT-1C	PAT-1C	PAT-1C	PAT-1C	PAT-1C	PAT-1C	PAT-1C	PAT-1C	PAT-1C	PAT-1C	PAT-1C	PAT-1C
CIMENTACIÓN	S(1x15/600/3)	ES(1x15/600/3)	ES(1x15/600/3)	ES(1x15/600/3)	ES(1x15/600/3)	ES(1x15/600/3)	ES(1x15/600/3)	ERRT(1x15/2700)	T(1x15/2700/3)	ES(1x15/600/3)	ES(1x15/600/3)	ES(1x15/600/3)	ES(1x15/600/3)	ES(1x15/600/3)	ES(1x15/600/3)	ES(1x15/600/3)
AMORTIGUADORES	-/-	-/-	-/-	-/-	-/-	-/-	-/-	-/-	-/-	-/-	-/-	-/-	-/-	-/-	-/-	-/-
AMORTIGUADORES-G	-/-	-/-	-/-	-/-	-/-	-/-	-/-	-/-	-/-	-/-	-/-	-/-	-/-	-/-	-/-	-/-
VANO HORIZONTAL (m)		94.03	93.86	93.86	93.82	93.84	93.39	93.62		93.16	93.61	93.84	93.84	93.84	93.84	93.84
VANO REGULADOR (m)		93.83	93.83	93.83	93.83	93.83	93.83	93.83		93.79	93.79	93.79	93.79	93.79	93.79	93.79
PARÁMETRO CATENARIA (m)		1518.17	1518.17	1518.17	1518.17	1518.17	1518.17	1518.17		1518.17	1518.17	1518.17	1518.17	1518.17	1518.17	1518.17
PARÁM. CAT. - G (m)		2577.53	2577.53	2577.53	2577.53	2577.53	2577.53	2577.53		2577.53	2577.53	2577.53	2577.53	2577.53	2577.53	2577.53
CONDUCTOR	1xIRAM 95/15 ACSR	1xIRAM 95/15 ACSR	1xIRAM 95/15 ACSR	1xIRAM 95/15 ACSR	1xIRAM 95/15 ACSR	1xIRAM 95/15 ACSR	1xIRAM 95/15 ACSR	1xIRAM 95/15 ACSR		1xIRAM 95/15 ACSR	1xIRAM 95/15 ACSR	1xIRAM 95/15 ACSR	1xIRAM 95/15 ACSR	1xIRAM 95/15 ACSR	1xIRAM 95/15 ACSR	1xIRAM 95/15 ACSR
CONDUCTOR-G	1xHilo_Guarda_25/7	1xHilo_Guarda_25/7	1xHilo_Guarda_25/7	1xHilo_Guarda_25/7	1xHilo_Guarda_25/7	1xHilo_Guarda_25/7	1xHilo_Guarda_25/7	1xHilo_Guarda_25/7		1xHilo_Guarda_25/7	1xHilo_Guarda_25/7	1xHilo_Guarda_25/7	1xHilo_Guarda_25/7	1xHilo_Guarda_25/7	1xHilo_Guarda_25/7	1xHilo_Guarda_25/7

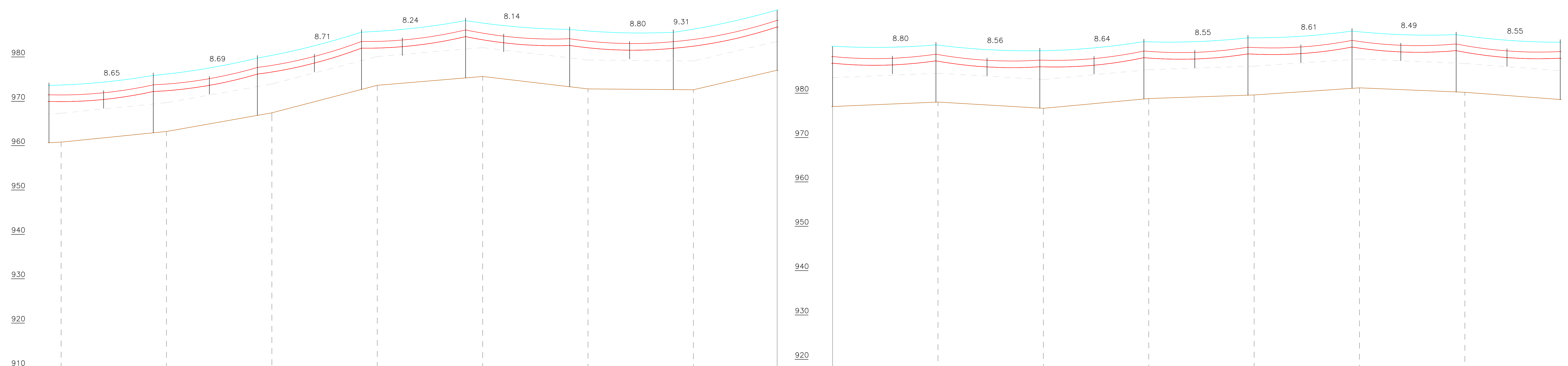

ESTACIÓN	RU-46															
DISTANCIA PARCIAL (m)	95.00	95.00	95.00	95.00	95.00	95.00	95.00	95.00	95.00	95.00	95.00	95.00	95.00	95.00	95.00	95.00
DISTANCIA ACUMULADA (m)	17376.59	17471.59	17566.59	17661.59	17756.59	17851.59	17946.59	18022.06	18022.06	18117.06	18212.06	18307.06	18402.06	18497.06	18592.06	18687.06
COTA DE TERRENO (m)	960.80	963.20	967.40	973.60	975.60	972.80	972.60	977.00	977.00	978.00	976.60	978.80	979.60	981.20	980.20	978.4
TIPO DE TERRENO																
PROPIETARIO																

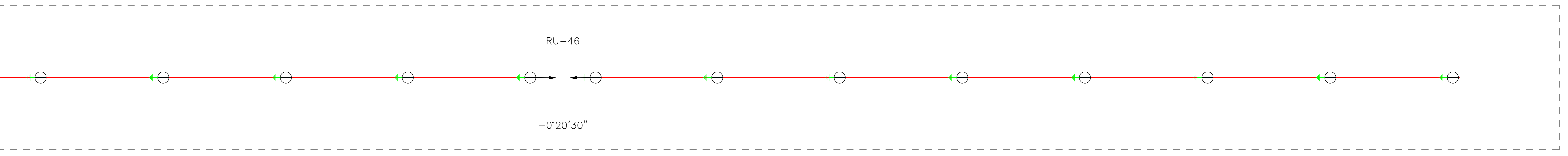
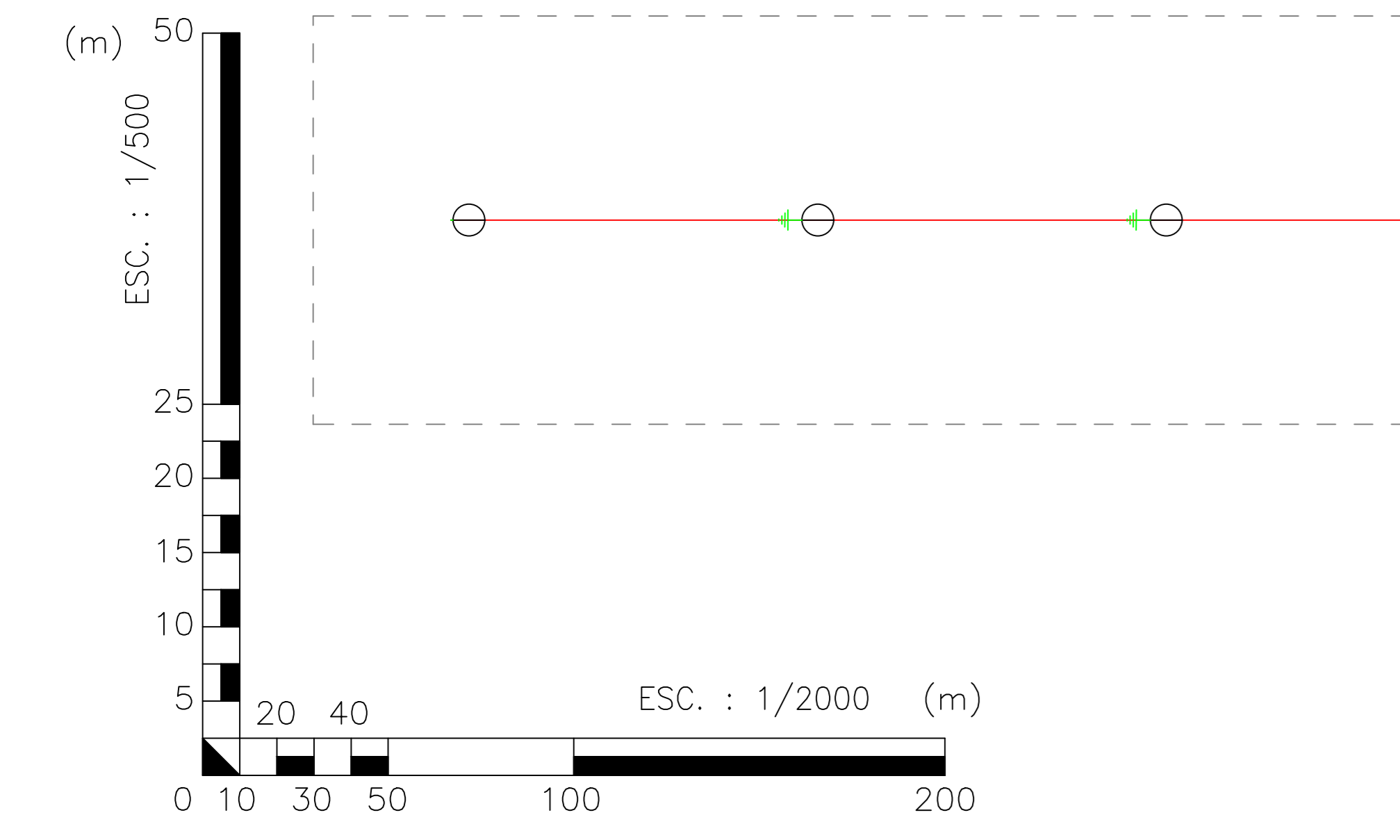

2.15				COMITENTE GOBIERNO DE LA PROVINCIA DE SALTA MINISTERIO DE INFRAESTRUCTURA. GOBIERNO DE SALTA.		OBRA : "TENDIDO DE LINEA DE MEDIA TENSION EN 33 KV CON HILO DE GUARDIA DESDE EL PARQUE INDUSTRIAL Y HASTA LA ENTRADA AL ACCESO POR LA RUTA NAC.º9 A LA LOCALIDAD DEL LA CANDELARIA-EL JARDIN - EL TALA-E603021090356- DSC 6177/21-NIS5337113.		DIS. : Ing. MARIO ALFARO REV. : - APR. : - DIB. : Arq. MARIEL ALFARO		DEPARTAMENTO: ROSARIO DE LA FRONTERA PROVINCIA : SALTA DISTRITO : METAN FECHA :		ESCALA : H : 1/2000 V : 1/500		PLANO : 15/28 01-L.M.T.33 KV	
REV.	DESCRIPCIÓN	DISÑO	DIBUJO	APROBADO	FECHA	RUTA Distribución de Estructuras PERFIL Y PLANIMETRIA : 17.37 km A 18.68 km									

NÚMERO DE ESTRUCTURA	207	208	209	210	211	212	213	214	215	216	216	217	217	218	218	219	219	220	
ARMADO PRINCIPAL	-PENSION SIMPLE	SUSPENSION SIMPLE	SUSPENSION SIMPLE	SUSPENSION SIMPLE	SUSPENSION SIMPLE	SUSPENSION SIMPLE	SUSPENSION SIMPLE	SUSPENSION SIMPLE	SUSPENSION SIMPLE	RA O A 30	RA O A 30	RA O A 30	RA O A 30	RA O A 30	RA O A 30	RA O A 30	RA O A 30	RA O A 30	
ACUMULADA (m)	18678.02	18771.85	18865.69	18959.53	19053.37	19147.20	19241.04	19334.88	19428.71	19522.30	19522.30	19602.07	19602.07	19682.92	19682.92	19762.35	19762.35	19842.40	
VANO VIENTO (m)	93.84	93.84	93.84	93.84	93.84	93.84	93.84	93.84	93.84	93.71	86.68	86.68	80.31	80.31	80.14	80.14	79.74	79.74	86.58
VANO PESO (m)	68.92	139.47	66.06	94.73	59.21	85.08	101.28	87.64	58.85	134.54	134.54	12.85	12.85	105.53	105.53	106.66	106.66	198.02	
SOPORTE	3(1x15/600/3)	ES(1x15/600/3)	ES(1x15/600/3)	ES(1x15/600/3)	ES(1x15/600/3)	ES(1x15/600/3)	ES(1x15/600/3)	ES(1x15/600/3)	ES(1x15/600/3)	ERA-0-30(1x15/2700)	-0-30(1x15/2700/3)	ERA-0-30(1x15/2700)	-0-30(1x15/2700/3)	ERA-0-30(1x15/2700)	-0-30(1x15/2700/3)	ERA-0-30(1x15/2700)	-0-30(1x15/2700/3)	ERA-0-30(1x15/2700)	
RETENIDAS																			
PUESTA A TIERRA	PAT-1C	PAT-1C	PAT-1C	PAT-1C	PAT-1C	PAT-1C	PAT-1C	PAT-1C	PAT-1C	PAT-1C	PAT-1C	PAT-1C	PAT-1C	PAT-1C	PAT-1C	PAT-1C	PAT-1C	PAT-1C	
CIMENTACIÓN	3(1x15/600/3)	ES(1x15/600/3)	ES(1x15/600/3)	ES(1x15/600/3)	ES(1x15/600/3)	ES(1x15/600/3)	ES(1x15/600/3)	ES(1x15/600/3)	ES(1x15/600/3)	ES(1x15/600/3)	ERA-0-30(1x15/2700)	-0-30(1x15/2700/3)	ERA-0-30(1x15/2700)	-0-30(1x15/2700/3)	ERA-0-30(1x15/2700)	-0-30(1x15/2700/3)	ERA-0-30(1x15/2700)	-0-30(1x15/2700/3)	ERA-0-30(1x15/2700)
AMORTIGUADORES	-/-	-/-	-/-	-/-	-/-	-/-	-/-	-/-	-/-	-/-	-/-	-/-	-/-	-/-	-/-	-/-	-/-	-/-	
AMORTIGUADORES-G	-/-	-/-	-/-	-/-	-/-	-/-	-/-	-/-	-/-	-/-	-/-	-/-	-/-	-/-	-/-	-/-	-/-	-/-	
VANO HORIZONTAL (m)		93.84	93.84	93.84	93.84	93.84	93.84	93.84	93.84	93.59		79.77		80.85		79.43		80.04	
VANO REGULADOR (m)		93.79	93.79	93.79	93.79	93.79	93.79	93.79	93.79	93.79		79.77		80.85		79.43		80.04	
PARÁMETRO CATENARIA (m)		1518.17	1518.17	1518.17	1518.17	1518.17	1518.17	1518.17	1518.17	1518.17		1518.17		1518.17		1518.17		1518.17	
PARÁM. CAT. - G (m)		2577.53	2577.53	2577.53	2577.53	2577.53	2577.53	2577.53	2577.53	2577.53		2577.53		2577.53		2577.53		2577.53	
CONDUCTOR	1xIRAM 95/15 ACSR	1xIRAM 95/15 ACSR	1xIRAM 95/15 ACSR	1xIRAM 95/15 ACSR	1xIRAM 95/15 ACSR	1xIRAM 95/15 ACSR	1xIRAM 95/15 ACSR	1xIRAM 95/15 ACSR	1xIRAM 95/15 ACSR	1xIRAM 95/15 ACSR		1xIRAM 95/15 ACSR		1xIRAM 95/15 ACSR		1xIRAM 95/15 ACSR		1xIRAM 95/15 ACSR	
CONDUCTOR-G	1xHilo_Guarda_25/7	1xHilo_Guarda_25/7	1xHilo_Guarda_25/7	1xHilo_Guarda_25/7	1xHilo_Guarda_25/7	1xHilo_Guarda_25/7	1xHilo_Guarda_25/7	1xHilo_Guarda_25/7	1xHilo_Guarda_25/7	1xHilo_Guarda_25/7		1xHilo_Guarda_25/7		1xHilo_Guarda_25/7		1xHilo_Guarda_25/7		1xHilo_Guarda_25/7	

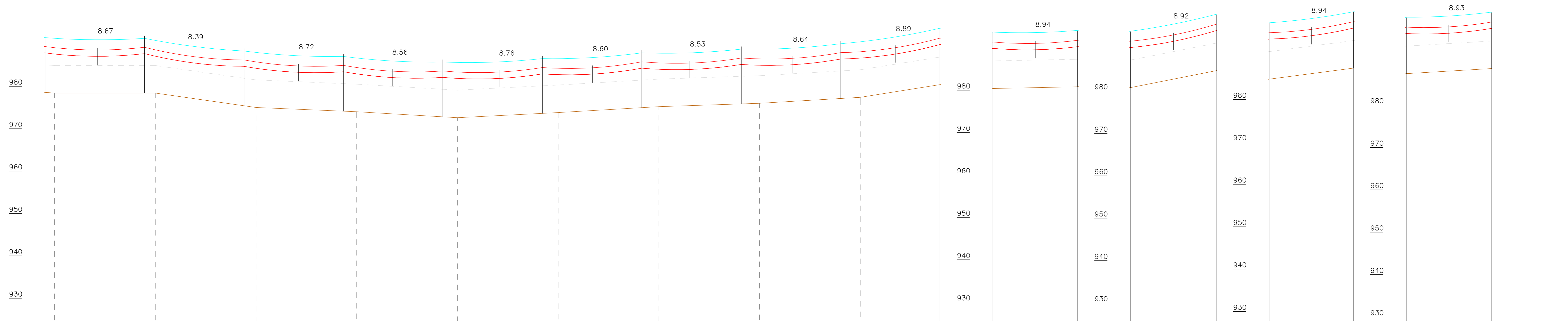

ESTACIÓN	-																RU-47	RU-47	RU-48	RU-48	RU-49	RU-49	RU-50	RU-50	RU-51
DISTANCIA PARCIAL (m)	95.00	95.00	95.00	95.00	95.00	95.00	95.00	95.00	95.00	95.00	95.00	95.00	95.00	95.00	95.00	95.00	95.00	95.00							
DISTANCIA ACUMULADA (m)	18687.06	18782.06	18877.06	18972.06	19067.06	19162.06	19257.06	19352.06	19447.06	19522.30	19522.30	19602.07	19602.07	19682.92	19682.92	19762.35	19762.35	19842.40							
COTA DE TERRENO (m)	978.40	978.40	975.00	974.00	972.60	973.80	975.20	976.00	977.40	980.40	980.40	980.80	980.80	984.80	984.80	987.40	987.40	988.60							
TIPO DE TERRENO																									
PROPIETARIO																									

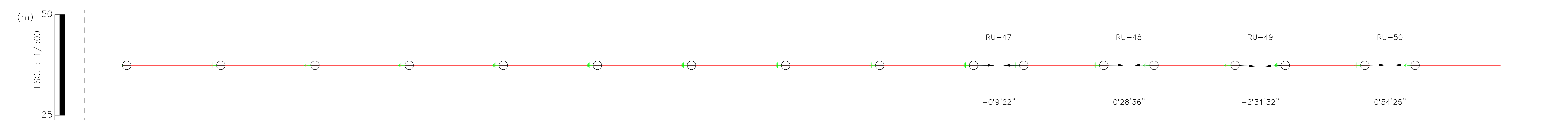

2.16				COMITENTE GOBIERNO DE LA PROVINCIA DE SALTA MINISTERIO DE INFRAESTRUCTURA. GOBIERNO DE SALTA.		OBRA : "TENDIDO DE LINEA DE MEDIA TENSION EN 33 KV CON HILO DE GUARDIA DESDE EL PARQUE INDUSTRIAL Y HASTA LA ENTRADA AL ACCESO POR LA RUTA NAC.º9 A LA LOCALIDAD DEL LA CANDELARIA-EL JARDIN - EL TALA-E603021090356- DSC 0177/21-NIS5337113.		DIS. : Ing. MARIO ALFARO		DEPARTAMENTO: ROSARIO DE LA FRONTERA	
								REV. :-		PROVINCIA : SALTA	
								APR. :-		DISTRITO : METAN	
								DIB. : Arq. MARIEL ALFARO		FECHA :	
								ESCALA : H :1/2000 V :1/500		PLANO : 16/28 01-L.M.T.33 KV	
REV.	DESCRIPCIÓN	DISEÑO	DIBUJO	APROBADO	FECHA						

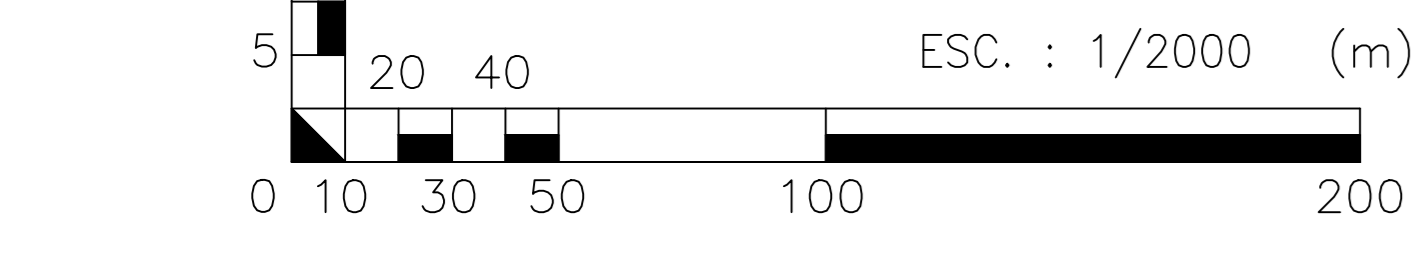

NÚMERO DE ESTRUCTURA	235	236	236	237	238	239	239	240	240	241	241	242	242	243	243	244	244	245	245	246
ARMADO PRINCIPAL	PENSION SIMPLE	RETENCION SIMF	TENCION SIMPLE	SUSPENSION SIMPLE	SUSPENSION SIMPLE	RA O A 30	RA O A 30	RA O A 30	RA O A 30	RA O A 30	RA O A 30	RA O A 30	RA O A 30	RA O A 30	RA O A 30	RA O A 30	RA O A 30	RA O A 30	RA O A 30	RA O A 30
ACUMULADA (m)	21248.64	21342.27	21342.27	21428.96	21515.64	21602.29	21602.29	21682.56	21682.56	21762.72	21762.72	21843.02	21843.02	21922.62	21922.62	22002.43	22002.43	22082.48	22082.48	22162.90
VANO VIENTO (m)	93.50	90.16	90.16	86.68	86.67	83.46	83.46	80.21	80.21	80.23	80.23	79.95	79.95	79.70	79.70	79.93	79.93	80.24	80.24	86.84
VANO PESO (m)	92.66	149.05	149.05	61.46	61.46	89.20	89.20	159.56	159.56	80.26	80.26	37.87	37.87	190.15	190.15	26.68	26.68	95.34	95.34	77.39
SOPORTE	3(1x15/600/3)	ERRT(1x15/2700)	T(1x15/2700/3)	ES(1x15/600/3)	ES(1x15/600/3)	ERA-0-30(1x15/2700)	-0-30(1x15/2700/3)	ERA-0-30(1x15/2700)	-0-30(1x15/2700/3)	ERA-0-30(1x15/2700)	-0-30(1x15/2700/3)	ERA-0-30(1x15/2700)	-0-30(1x15/2700/3)	ERA-0-30(1x15/2700)	-0-30(1x15/2700/3)	ERA-0-30(1x15/2700)	-0-30(1x15/2700/3)	ERA-0-30(1x15/2700)	-0-30(1x15/2700/3)	ERA-0-30(1x15/2700)
RETENIDAS																				
PUESTA A TIERRA	PAT-1C	PAT-1C	PAT-1C	PAT-1C	PAT-1C	PAT-1C	PAT-1C	PAT-1C	PAT-1C	PAT-1C	PAT-1C	PAT-1C	PAT-1C	PAT-1C	PAT-1C	PAT-1C	PAT-1C	PAT-1C	PAT-1C	PAT-1C
CIMENTACIÓN	3(1x15/600/3)	ERRT(1x15/2700)	T(1x15/2700/3)	ES(1x15/600/3)	ES(1x15/600/3)	ERA-0-30(1x15/2700)	-0-30(1x15/2700/3)	ERA-0-30(1x15/2700)	-0-30(1x15/2700/3)	ERA-0-30(1x15/2700)	-0-30(1x15/2700/3)	ERA-0-30(1x15/2700)	-0-30(1x15/2700/3)	ERA-0-30(1x15/2700)	-0-30(1x15/2700/3)	ERA-0-30(1x15/2700)	-0-30(1x15/2700/3)	ERA-0-30(1x15/2700)	-0-30(1x15/2700/3)	ERA-0-30(1x15/2700)
AMORTIGUADORES	-/-	-/-	-/-	-/-	-/-	-/-	-/-	-/-	-/-	-/-	-/-	-/-	-/-	-/-	-/-	-/-	-/-	-/-	-/-	-/-
AMORTIGUADORES-G	-/-	-/-	-/-	-/-	-/-	-/-	-/-	-/-	-/-	-/-	-/-	-/-	-/-	-/-	-/-	-/-	-/-	-/-	-/-	-/-
VANO HORIZONTAL (m)		93.63		86.69	86.68	86.65		80.27		80.16		80.31		79.59		79.81		80.05		80.43
VANO REGULADOR (m)		93.80		86.68	86.68	86.68		80.27		80.16		80.31		79.59		79.81		80.05		80.43
PARÁMETRO CATENARIA (m)		1518.17		1518.17	1518.17	1518.17		1518.17		1518.17		1518.17		1518.17		1518.17		1518.17		1518.17
PARÁM. CAT. - G (m)		2577.53		2577.53	2577.53	2577.53		2577.53		2577.53		2577.53		2577.53		2577.53		2577.53		2577.53
CONDUCTOR	1xIRAM 95/15 ACSR		1xIRAM 95/15 ACSR	1xIRAM 95/15 ACSR	1xIRAM 95/15 ACSR	1xIRAM 95/15 ACSR		1xIRAM 95/15 ACSR		1xIRAM 95/15 ACSR		1xIRAM 95/15 ACSR		1xIRAM 95/15 ACSR		1xIRAM 95/15 ACSR		1xIRAM 95/15 ACSR		1xIRAM 95/15 ACSR
CONDUCTOR-G	1xHilo_Guarda_25/7		1xHilo_Guarda_25/7	1xHilo_Guarda_25/7	1xHilo_Guarda_25/7	1xHilo_Guarda_25/7		1xHilo_Guarda_25/7		1xHilo_Guarda_25/7		1xHilo_Guarda_25/7		1xHilo_Guarda_25/7		1xHilo_Guarda_25/7		1xHilo_Guarda_25/7		1xHilo_Guarda_25/7

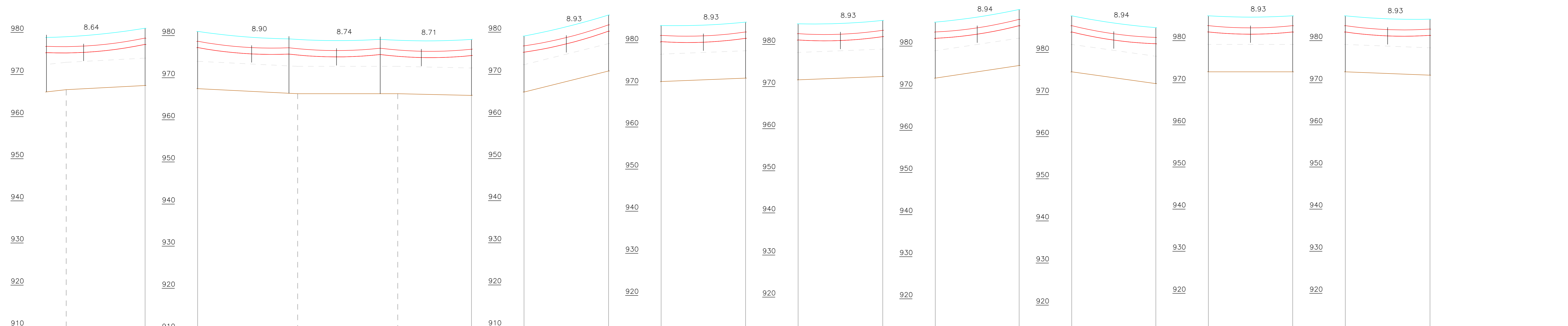

ESTACIÓN	-	RU-52	RU-52	-	-	RU-53	RU-53	RU-54	RU-54	RU-55	RU-55	RU-56	RU-56	RU-57	RU-57	RU-58	RU-58	RU-59	RU-59	RU-60
DISTANCIA PARCIAL (m)		74.87		95.00		21532.27		70.02		80.27		80.16		80.31		79.59		79.81		80.43
DISTANCIA ACUMULADA (m)	21267.40	21342.27	21342.27	21437.27	21532.27	21602.29	21602.29	21682.56	21682.56	21762.72	21762.72	21843.02	21843.02	21922.62	21922.62	22002.43	22002.43	22082.48	22082.48	22162.90
COTA DE TERRENO (m)	966.40	967.40	967.40	966.20	966.20	965.80	965.80	970.80	970.80	971.60	971.60	972.40	972.40	975.40	975.40	972.60	972.60	972.60	972.60	971.80
TIPO DE TERRENO																				
PROPIETARIO																				

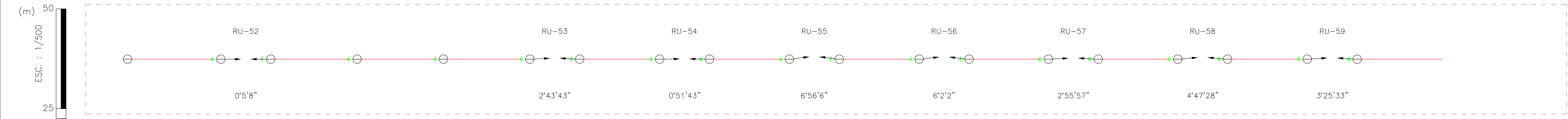

<p>2.18</p>				<p>COMITENTE GOBIERNO DE LA PROVINCIA DE SALTA MINISTERIO DE INFRAESTRUCTURA. GOBIERNO DE SALTA.</p>		<p>OBRA : "TENDIDO DE LINEA DE MEDIA TENSION EN 33 KV CON HILO DE GUARDIA DESDE EL PARQUE INDUSTRIAL Y HASTA LA ENTRADA AL ACCESO POR LA RUTA NAC.Nº9 A LA LOCALIDAD DEL LA CANDELARIA-EL JARDIN - EL TALA-E603021090356- DSC 0177/21-NIS537113.</p>		<p>DIS. : Ing. MARIO ALFARO</p>		<p>DEPARTAMENTO: ROSARIO DE LA FRONTERA PROVINCIA : SALTA DISTRITO : METAN FECHA :</p>	
<p>REV. DESCRIPCIÓN DISEÑO DIBUJO APROBADO FECHA</p>				<p>RUTA Distribución de Estructuras PERFIL Y PLANIMETRÍA : 21.25 km A 22.16 km</p>		<p>APR. :-</p>		<p>ESCALA : H : 1/2000 V : 1/500</p>		<p>PLANO : 18/28 01-L.M.T.33 KV</p>	

NÚMERO DE ESTRUCTURA	246	247	248	249	250	251	252	253	254	255	256	257	258	259	260	261
ARMADO PRINCIPAL	RA 0 A 30	SUSPENSION SIMPLE	SUSPENSION SIMPLE	SUSPENSION SIMPLE	SUSPENSION SIMPLE	SUSPENSION SIMPLE	SUSPENSION SIMPLE	SUSPENSION SIMPLE	SUSPENSION SIMPLE	SUSPENSION SIMPLE	SUSPENSION SIMPLE	SUSPENSION SIMPLE	SUSPENSION SIMPLE	SUSPENSION SIMPLE	SUSPENSION SIMPLE	SUSPENSION SIM
ACUMULADA (m)	22162.90	22256.16	22349.78	22443.39	22537.00	22630.61	22724.45	22818.38	22912.03	23005.97	23099.62	23193.56	23287.51	23381.31	23475.14	23568.98
VANO VIENTO (m)	86.84	93.44	93.61	93.61	93.61	93.72	93.88	93.79	93.79	93.79	93.79	93.94	93.87	93.82	93.84	93.84
VANO PESO (m)	77.39	134.89	103.70	45.28	130.07	75.72	100.87	80.30	92.17	68.70	65.44	79.05	148.01	112.72	79.99	103.70
SOPORTE	-0-30(1x15/2700/3)	ES(1x15/600/3)	ES(1x15/600/3)	ES(1x15/600/3)	ES(1x15/600/3)	ES(1x15/600/3)	ES(1x15/600/3)	ES(1x15/600/3)	ES(1x15/600/3)	ES(1x15/600/3)	ES(1x15/600/3)	ES(1x15/600/3)	ES(1x15/600/3)	ES(1x15/600/3)	ES(1x15/600/3)	ES(1x15/600/3)
RETENIDAS																
PUESTA A TIERRA	PAT-1C	PAT-1C	PAT-1C	PAT-1C	PAT-1C	PAT-1C	PAT-1C	PAT-1C	PAT-1C	PAT-1C	PAT-1C	PAT-1C	PAT-1C	PAT-1C	PAT-1C	PAT-1C
CIMENTACIÓN	-0-30(1x15/2700/3)	ES(1x15/600/3)	ES(1x15/600/3)	ES(1x15/600/3)	ES(1x15/600/3)	ES(1x15/600/3)	ES(1x15/600/3)	ES(1x15/600/3)	ES(1x15/600/3)	ES(1x15/600/3)	ES(1x15/600/3)	ES(1x15/600/3)	ES(1x15/600/3)	ES(1x15/600/3)	ES(1x15/600/3)	ES(1x15/600/3)
AMORTIGUADORES	-/-	-/-	-/-	-/-	-/-	-/-	-/-	-/-	-/-	-/-	-/-	-/-	-/-	-/-	-/-	-/-
AMORTIGUADORES-G	-/-	-/-	-/-	-/-	-/-	-/-	-/-	-/-	-/-	-/-	-/-	-/-	-/-	-/-	-/-	-/-
VANO HORIZONTAL (m)		93.26	93.61	93.61	93.61	93.61	93.84	93.93	93.64	93.94	93.64	93.94	93.78	93.80	93.84	93.84
VANO REGULADOR (m)		93.78	93.78	93.78	93.78	93.78	93.78	93.78	93.78	93.78	93.78	93.78	93.78	93.78	93.78	93.78
PARÁMETRO CATENARIA (m)		1518.17	1518.17	1518.17	1518.17	1518.17	1518.17	1518.17	1518.17	1518.17	1518.17	1518.17	1518.17	1518.17	1518.17	1518.17
PARÁM. CAT. - G (m)		2577.53	2577.53	2577.53	2577.53	2577.53	2577.53	2577.53	2577.53	2577.53	2577.53	2577.53	2577.53	2577.53	2577.53	2577.53
CONDUCTOR	1xIRAM 95/15 ACSR	1xIRAM 95/15 ACSR	1xIRAM 95/15 ACSR	1xIRAM 95/15 ACSR	1xIRAM 95/15 ACSR	1xIRAM 95/15 ACSR	1xIRAM 95/15 ACSR	1xIRAM 95/15 ACSR	1xIRAM 95/15 ACSR	1xIRAM 95/15 ACSR	1xIRAM 95/15 ACSR	1xIRAM 95/15 ACSR	1xIRAM 95/15 ACSR	1xIRAM 95/15 ACSR	1xIRAM 95/15 ACSR	1xIRAM 95/15 ACSR
CONDUCTOR-G	1xHilo_Guarda_25/7	1xHilo_Guarda_25/7	1xHilo_Guarda_25/7	1xHilo_Guarda_25/7	1xHilo_Guarda_25/7	1xHilo_Guarda_25/7	1xHilo_Guarda_25/7	1xHilo_Guarda_25/7	1xHilo_Guarda_25/7	1xHilo_Guarda_25/7	1xHilo_Guarda_25/7	1xHilo_Guarda_25/7	1xHilo_Guarda_25/7	1xHilo_Guarda_25/7	1xHilo_Guarda_25/7	1xHilo_Guarda_25/7

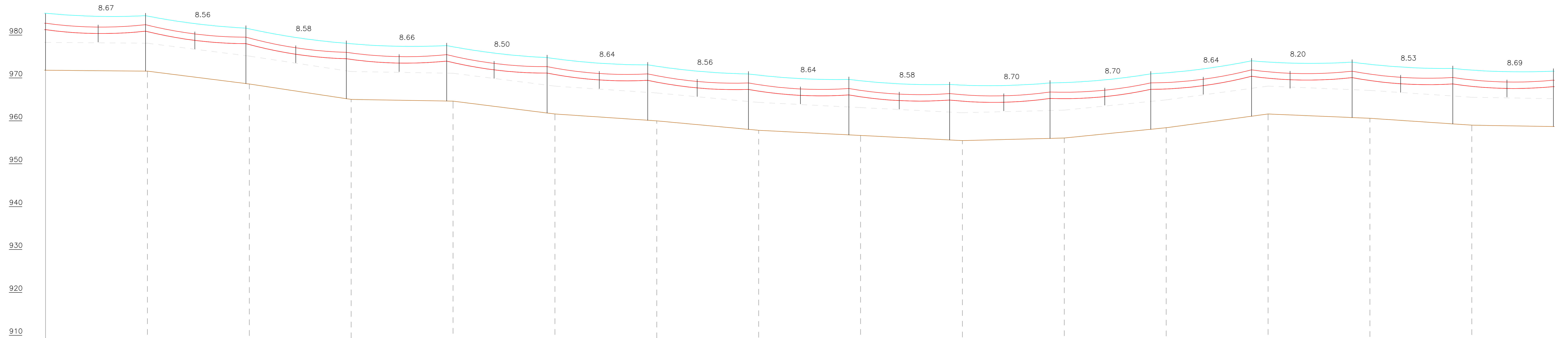

ESTACIÓN	RU-60	-	-	-	-	-	-	-	-	-	-	-	-	-	-	-	-	-	-
DISTANCIA PARCIAL (m)	95.00	95.00	95.00	95.00	95.00	95.00	95.00	95.00	95.00	95.00	95.00	95.00	95.00	95.00	95.00	95.00	95.00	95.00	95.00
DISTANCIA ACUMULADA (m)	22162.90	22257.90	22352.90	22447.90	22542.90	22637.90	22732.90	22827.90	22922.90	23017.90	23112.90	23207.90	23302.90	23397.90	23492.90	23568.98			
COTA DE TERRENO (m)	971.80	971.60	968.60	965.00	964.60	961.60	960.00	957.80	956.60	955.40	956.00	958.40	961.60	960.60	959.00	95			
TIPO DE TERRENO																			
PROPIETARIO																			

(m) 50
ESC. : 1/500

RU-60

0°58'50"

20 40
0 100 200

ESC. : 1/2000 (m)

2.19

COMITENTE
GOBIERNO DE LA PROVINCIA DE SALTA
MINISTERIO DE INFRAESTRUCTURA
GOBIERNO DE SALTA.

OBRA : TENDIDO DE LINEA DE MEDIA TENSION EN 33 KV CON HILO DE GUARDIA DESDE EL PARQUE INDUSTRIAL Y HASTA LA ENTRADA AL ACCESO POR LA RUTA NAC. Nº9 A LA LOCALIDAD DEL LA CANDELARIA-EL JARDIN - EL TALA-E603021090356-DSC 0177/21-NIS537113.

RUTA
Distribución de Estructuras
PERFIL Y PLANIMETRÍA : 22.16 km A 23.57 km

DIS. : Ing. MARIO ALFARO
REV. : -
APR. : -
DIB. : Arq. MARIEL ALFARO

DEPARTAMENTO: ROSARIO DE LA FRONTERA
PROVINCIA : SALTA
DISTRITO : METAN
FECHA :
ESCALA :
H : 1/2000
V : 1/500
PLANO : 19/28
01-L.M.T.33 KV

REV.	DESCRIPCIÓN	DISEÑO	DIBUJO	APROBADO	FECHA

NÚMERO DE ESTRUCTURA	261	262	262	263	264	265	266	267	268	269	270	271	272	273	274	274	275
ARMADO PRINCIPAL	PENSION SIMPLE	RETENCION SIMF	TENCION SIMPLE	SUSPENSION SIMPLE	SUSPENSION SIMPLE	SUSPENSION SIMPLE	SUSPENSION SIMPLE	SUSPENSION SIMPLE	SUSPENSION SIMPLE	SUSPENSION SIMPLE	SUSPENSION SIMPLE	SUSPENSION SIMPLE	SUSPENSION SIMPLE	SUSPENSION SIMPLE	RA O A 30	RA O A 30	RA O A 30
ACUMULADA (m)	23568.98	23662.83	23662.83	23757.83	23852.83	23947.83	24042.83	24137.83	24232.83	24327.83	24422.83	24517.83	24612.83	24707.83	24803.60	24803.60	24883.11
VANO VIENTO (m)	93.84	94.43	94.43	95.00	95.00	95.00	95.00	95.00	95.00	95.00	95.00	95.00	95.00	95.38	87.64	87.64	79.73
VANO PESO (m)	103.70	100.92	100.92	59.04	107.78	75.83	117.37	130.15	66.24	66.24	69.44	123.76	63.05	112.37	111.57	111.57	53.16
SOPORTE	3(1x15/600/3)	ERRT(1x15/2700)	T(1x15/2700/3)	ES(1x15/600/3)	ES(1x15/600/3)	ES(1x15/600/3)	ES(1x15/600/3)	ES(1x15/600/3)	ES(1x15/600/3)	ES(1x15/600/3)	ES(1x15/600/3)	ES(1x15/600/3)	ES(1x15/600/3)	ES(1x15/600/3)	ERA-0-30(1x15/2700)	-0-30(1x15/2700/3)	ERA-0-30(1x15/2700)
RETENIDAS																	
PUESTA A TIERRA	PAT-1C	PAT-1C	PAT-1C	PAT-1C	PAT-1C	PAT-1C	PAT-1C	PAT-1C	PAT-1C	PAT-1C	PAT-1C	PAT-1C	PAT-1C	PAT-1C	PAT-1C	PAT-1C	PAT-1C
CIMENTACIÓN	3(1x15/600/3)	ERRT(1x15/2700)	T(1x15/2700/3)	ES(1x15/600/3)	ES(1x15/600/3)	ES(1x15/600/3)	ES(1x15/600/3)	ES(1x15/600/3)	ES(1x15/600/3)	ES(1x15/600/3)	ES(1x15/600/3)	ES(1x15/600/3)	ES(1x15/600/3)	ES(1x15/600/3)	ERA-0-30(1x15/2700)	-0-30(1x15/2700/3)	ERA-0-30(1x15/2700)
AMORTIGUADORES	-/-	-/-	-/-	-/-	-/-	-/-	-/-	-/-	-/-	-/-	-/-	-/-	-/-	-/-	-/-	-/-	-/-
AMORTIGUADORES-G	-/-	-/-	-/-	-/-	-/-	-/-	-/-	-/-	-/-	-/-	-/-	-/-	-/-	-/-	-/-	-/-	-/-
VANO HORIZONTAL (m)		93.85		95.00	95.00	95.00	95.00	95.00	95.00	95.00	95.00	95.00	95.00	95.00	95.76		79.52
VANO REGULADOR (m)		93.78		95.08	95.08	95.08	95.08	95.08	95.08	95.08	95.08	95.08	95.08	95.08	95.08		79.52
PARÁMETRO CATENARIA (m)		1518.17		1518.17	1518.17	1518.17	1518.17	1518.17	1518.17	1518.17	1518.17	1518.17	1518.17	1518.17	1518.17		1518.17
PARÁM. CAT. - G (m)		2577.53		2577.53	2577.53	2577.53	2577.53	2577.53	2577.53	2577.53	2577.53	2577.53	2577.53	2577.53	2577.53		2577.53
CONDUCTOR	1xIRAM 95/15 ACSR		1xIRAM 95/15 ACSR	1xIRAM 95/15 ACSR	1xIRAM 95/15 ACSR	1xIRAM 95/15 ACSR	1xIRAM 95/15 ACSR	1xIRAM 95/15 ACSR	1xIRAM 95/15 ACSR	1xIRAM 95/15 ACSR	1xIRAM 95/15 ACSR	1xIRAM 95/15 ACSR	1xIRAM 95/15 ACSR	1xIRAM 95/15 ACSR	1xIRAM 95/15 ACSR		1xIRAM 95/15 ACSR
CONDUCTOR-G	1xHilo_Guarda_25/7		1xHilo_Guarda_25/7	1xHilo_Guarda_25/7	1xHilo_Guarda_25/7	1xHilo_Guarda_25/7	1xHilo_Guarda_25/7	1xHilo_Guarda_25/7	1xHilo_Guarda_25/7	1xHilo_Guarda_25/7	1xHilo_Guarda_25/7	1xHilo_Guarda_25/7	1xHilo_Guarda_25/7	1xHilo_Guarda_25/7	1xHilo_Guarda_25/7		1xHilo_Guarda_25/7

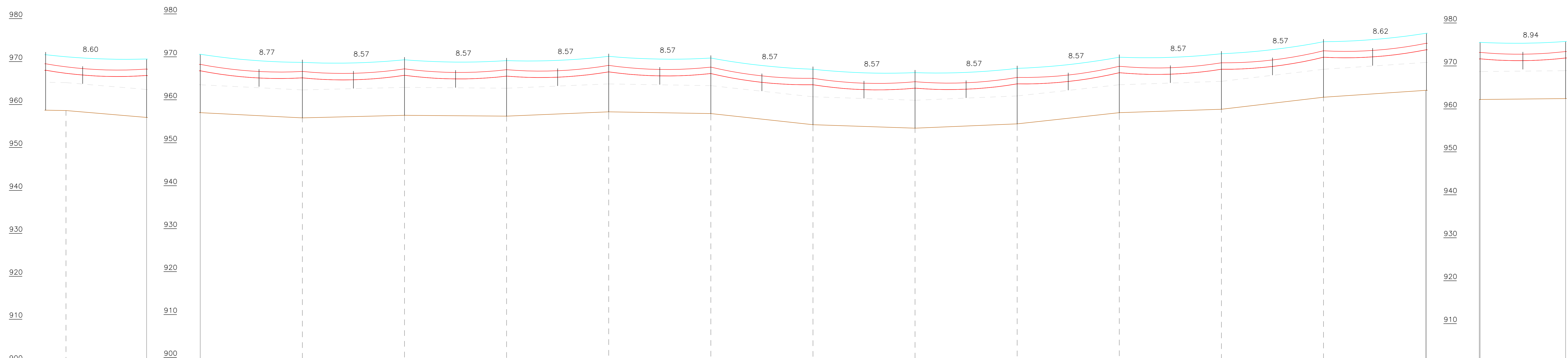

ESTACIÓN	-	RU-61	RU-61	-	-	-	-	-	-	-	-	-	-	-	-	-	-	-	-	-	RU-62	RU-62	RU-63	
DISTANCIA PARCIAL (m)		74.93		95.00																				
DISTANCIA ACUMULADA (m)	23587.90	23662.83	23662.83	23757.83	23852.83	23947.83	24042.83	24137.83	24232.83	24327.83	24422.83	24517.83	24612.83	24707.83	24803.60	24803.60	24883.11							
COTA DE TERRENO (m)	958.60	957.00	957.00	955.80	956.40	956.20	957.20	956.80	954.20	953.40	954.40	957.00	957.80	960.60	962.20	962.20	962.40							
TIPO DE TERRENO																								
PROPIETARIO																								

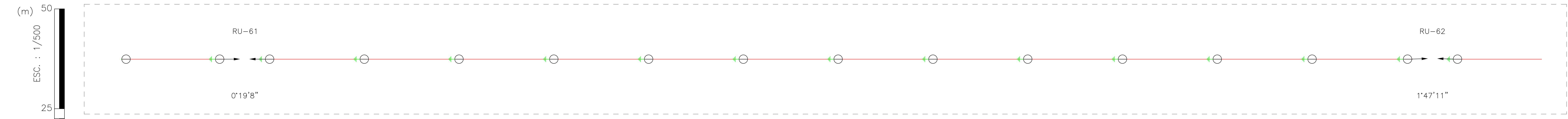

<p>2.20</p>				<p>COMITENTE GOBIERNO DE LA PROVINCIA DE SALTA MINISTERIO DE INFRAESTRUCTURA. GOBIERNO DE SALTA.</p>		<p>OBRA : "TENDIDO DE LINEA DE MEDIA TENSION EN 33 KV CON HILO DE GUARDIA DESDE EL PARQUE INDUSTRIAL Y HASTA LA ENTRADA AL ACCESO POR LA RUTA NAC.º9 A LA LOCALIDAD DEL LA CANDELARIA-EL JARDIN - EL TALA-E603021090356- DSC 0177/21-NIS5337113.</p>		<p>DIS. : Ing. MARIO ALFARO REV. :- APR. :- DIB. : Arq. MARIEL ALFARO</p>		<p>DEPARTAMENTO: ROSARIO DE LA FRONTERA PROVINCIA : SALTA DISTRITO : METAN FECHA :</p>	
<p>REV. DESCRIPCIÓN DISEÑO DIBUJO APROBADO FECHA</p>				<p>RUTA Distribución de Estructuras PERFIL Y PLANIMETRÍA : 23.57 km A 24.88 km</p>		<p>ESCALA : H : 1/2000 V : 1/500</p>		<p>PLANO : 20/28 01-L.M.T.33 KV</p>			

NÚMERO DE ESTRUCTURA	275	276	276	277	277	278	278	279	280	281	282	283	284	285	286	287	288	289
ARMADO PRINCIPAL	RA 0 A 30	RA 0 A 30	RA 0 A 30	RA 0 A 30	RA 0 A 30	RA 0 A 30	RA 0 A 30	SUSPENSION SIMPLE	SUSPENSION SIMPLE	SUSPENSION SIMPLE	SUSPENSION SIMPLE	SUSPENSION SIMPLE	SUSPENSION SIMPLE	SUSPENSION SIMPLE	SUSPENSION SIMPLE	SUSPENSION SIMPLE	SUSPENSION SIMPLE	SUSPENSION SIM
ACUMULADA (m)	24883.11	24963.05	24963.05	25043.51	25043.51	25123.72	25123.72	25217.32	25311.02	25404.64	25498.25	25592.09	25685.92	25779.76	25873.60	25967.43	26061.05	26154.88
VANO VIENTO (m)	79.73	80.20	80.20	80.33	80.33	86.90	86.90	93.65	93.66	93.61	93.72	93.84	93.84	93.84	93.84	93.72	93.72	93.84
VANO PESO (m)	53.16	129.45	129.45	103.10	103.10	66.88	66.88	100.65	106.21	75.65	89.88	102.56	91.58	64.67	125.00	61.33	108.06	124.10
SOPORTE	-0-30(1x15/2700/3)	ERA-0-30(1x15/2700/3)	-0-30(1x15/2700/3)	ERA-0-30(1x15/2700/3)	-0-30(1x15/2700/3)	ERA-0-30(1x15/2700/3)	-0-30(1x15/2700/3)	ES(1x15/600/3)	ES(1x15/600/3)	ES(1x15/600/3)	ES(1x15/600/3)	ES(1x15/600/3)	ES(1x15/600/3)	ES(1x15/600/3)	ES(1x15/600/3)	ES(1x15/600/3)	ES(1x15/600/3)	ES(1x15/600/3)
RETENIDAS																		
PUESTA A TIERRA	PAT-1C	PAT-1C	PAT-1C	PAT-1C	PAT-1C	PAT-1C	PAT-1C	PAT-1C	PAT-1C	PAT-1C	PAT-1C	PAT-1C	PAT-1C	PAT-1C	PAT-1C	PAT-1C	PAT-1C	PAT-1C
CIMENTACIÓN	-0-30(1x15/2700/3)	ERA-0-30(1x15/2700/3)	-0-30(1x15/2700/3)	ERA-0-30(1x15/2700/3)	-0-30(1x15/2700/3)	ERA-0-30(1x15/2700/3)	-0-30(1x15/2700/3)	ES(1x15/600/3)	ES(1x15/600/3)	ES(1x15/600/3)	ES(1x15/600/3)	ES(1x15/600/3)	ES(1x15/600/3)	ES(1x15/600/3)	ES(1x15/600/3)	ES(1x15/600/3)	ES(1x15/600/3)	ES(1x15/600/3)
AMORTIGUADORES	-/-	-/-	-/-	-/-	-/-	-/-	-/-	-/-	-/-	-/-	-/-	-/-	-/-	-/-	-/-	-/-	-/-	-/-
AMORTIGUADORES-G	-/-	-/-	-/-	-/-	-/-	-/-	-/-	-/-	-/-	-/-	-/-	-/-	-/-	-/-	-/-	-/-	-/-	-/-
VANO HORIZONTAL (m)		79.93		80.46		80.21		93.60		93.71		93.61		93.84		93.84		93.84
VANO REGULADOR (m)		79.93		80.46		80.21		93.78		93.78		93.78		93.78		93.78		93.78
PARÁMETRO CATENARIA (m)		1518.17		1518.17		1518.17		1518.17		1518.17		1518.17		1518.17		1518.17		1518.17
PARÁM. CAT. - G (m)		2577.53		2577.53		2577.53		2577.53		2577.53		2577.53		2577.53		2577.53		2577.53
CONDUCTOR	1xIRAM 95/15 ACSR		1xIRAM 95/15 ACSR		1xIRAM 95/15 ACSR		1xIRAM 95/15 ACSR		1xIRAM 95/15 ACSR		1xIRAM 95/15 ACSR		1xIRAM 95/15 ACSR		1xIRAM 95/15 ACSR		1xIRAM 95/15 ACSR	1xIRAM 95/15 ACSR
CONDUCTOR-G	1xHilo_Guarda_25/7		1xHilo_Guarda_25/7		1xHilo_Guarda_25/7		1xHilo_Guarda_25/7		1xHilo_Guarda_25/7		1xHilo_Guarda_25/7		1xHilo_Guarda_25/7		1xHilo_Guarda_25/7		1xHilo_Guarda_25/7	1xHilo_Guarda_25/7

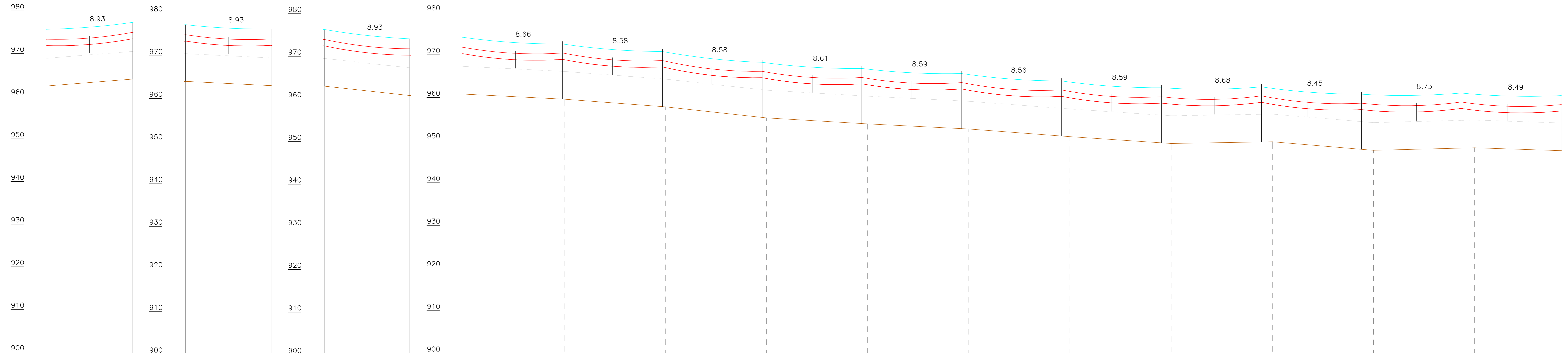

ESTACIÓN	RU-63	RU-64	RU-64	RU-65	RU-65	RU-66	RU-66	-	-	-	-	-	-	-	-	-	-	-
DISTANCIA PARCIAL (m)	79.93	80.46	80.21	95.00	95.00	95.00	95.00	95.00	95.00	95.00	95.00	95.00	95.00	95.00	95.00	95.00	95.00	95.00
DISTANCIA ACUMULADA (m)	24883.11	24963.05	24963.05	25043.51	25043.51	25123.72	25123.72	25218.72	25313.72	25408.72	25503.72	25598.72	25693.72	25788.72	25883.72	25978.72	26073.72	26161
COTA DE TERRENO (m)	962.40	964.00	964.00	963.00	963.00	960.80	960.80	959.80	957.80	955.20	953.80	952.60	950.80	949.20	949.60	947.60	948.20	947
TIPO DE TERRENO																		
PROPIETARIO																		

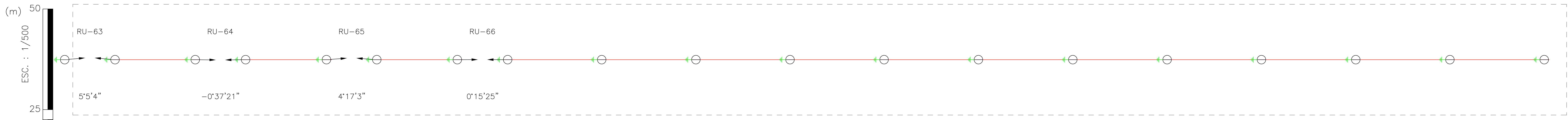

2.21				COMITENTE GOBIERNO DE LA PROVINCIA DE SALTA MINISTERIO DE INFRAESTRUCTURA GOBIERNO DE SALTA.		OBRA: "TENDIDO DE LINEA DE MEDIA TENSION EN 33 KV CON HILO DE GUARDIA DESDE EL PARQUE INDUSTRIAL Y HASTA LA ENTRADA AL ACCESO POR LA RUTA NAC.º9 A LA LOCALIDAD DEL LA CANDELARIA-EL JARDIN - EL TALA-E603021090356- DSC 6177/21-NI5537113.		DIS. : Ing. MARIO ALFARO		DEPARTAMENTO: ROSARIO DE LA FRONTERA PROVINCIA : SALTA DISTRITO : METAN FECHA :	
REV. DESCRIPCIÓN DISEÑO DIBUJO APROBADO FECHA				RUTA Distribución de Estructuras		APR. :-		ESCALA : H :1/2000 V :1/500		PLANO : 21/28 01-L.M.T.33 KV	
PERFIL Y PLANIMETRÍA : 24.88 km A 26.15 km						DIB. : Arq. MARIEL ALFARO					

NÚMERO DE ESTRUCTURA	289	290	291	292	293	294	294	295	296	297	298	299	300	301	302	302	303
ARMADO PRINCIPAL	PENSION SIMPLE	SUSPENSION SIMPLE	SUSPENSION SIMPLE	SUSPENSION SIMPLE	SUSPENSION SIMPLE	RETENCION SIMF	TENCION SIMPLE	SUSPENSION SIMPLE	SUSPENSION SIMPLE	SUSPENSION SIMPLE	SUSPENSION SIMPLE	SUSPENSION SIMPLE	SUSPENSION SIMPLE	SUSPENSION SIMPLE	RA 0 A 30	RA 0 A 30	RA 0 A 30
ACUMULADA (m)	26154.88	26248.72	26342.56	26436.17	26530.00	26623.92	26623.92	26709.95	26796.23	26882.51	26968.79	27055.07	27141.34	27227.62	27313.73	27313.73	27393.65
VANO VIENTO (m)	93.84	93.84	93.72	93.72	93.87	89.97	89.97	86.16	86.28	86.28	86.28	86.28	86.28	86.19	83.02	83.02	80.10
VANO PESO (m)	124.10	85.13	91.17	70.34	110.31	111.26	111.26	66.76	69.71	95.65	84.57	81.07	83.78	89.30	88.01	88.01	132.96
SOPORTE	3(1x15/600/3)	ES(1x15/600/3)	ES(1x15/600/3)	ES(1x15/600/3)	ES(1x15/600/3)	ERRT(1x15/2700	T(1x15/2700/3)	ES(1x15/600/3)	ES(1x15/600/3)	ES(1x15/600/3)	ES(1x15/600/3)	ES(1x15/600/3)	ES(1x15/600/3)	ES(1x15/600/3)	ERA-0-30(1x15/2700	-0-30(1x15/2700/3)	ERA-0-30(1x15/2700
RETENIDAS																	
PUESTA A TIERRA	PAT-1C	PAT-1C	PAT-1C	PAT-1C	PAT-1C	PAT-1C	PAT-1C	PAT-1C	PAT-1C	PAT-1C	PAT-1C	PAT-1C	PAT-1C	PAT-1C	PAT-1C	PAT-1C	PAT-1C
CIMENTACIÓN	3(1x15/600/3)	ES(1x15/600/3)	ES(1x15/600/3)	ES(1x15/600/3)	ES(1x15/600/3)	ERRT(1x15/2700	T(1x15/2700/3)	ES(1x15/600/3)	ES(1x15/600/3)	ES(1x15/600/3)	ES(1x15/600/3)	ES(1x15/600/3)	ES(1x15/600/3)	ES(1x15/600/3)	ERA-0-30(1x15/2700	-0-30(1x15/2700/3)	ERA-0-30(1x15/2700
AMORTIGUADORES	-/-	-/-	-/-	-/-	-/-	-/-	-/-	-/-	-/-	-/-	-/-	-/-	-/-	-/-	-/-	-/-	-/-
AMORTIGUADORES-G	-/-	-/-	-/-	-/-	-/-	-/-	-/-	-/-	-/-	-/-	-/-	-/-	-/-	-/-	-/-	-/-	-/-
VANO HORIZONTAL (m)		93.84	93.84	93.61	93.84	93.91	93.78	86.04	86.28	86.28	86.28	86.28	86.28	86.28	86.28	86.28	86.11
VANO REGULADOR (m)		93.78	93.78	93.78	93.78	93.78	86.24	86.24	86.24	86.24	86.24	86.24	86.24	86.24	86.24	86.24	79.93
PARÁMETRO CATENARIA (m)		1518.17	1518.17	1518.17	1518.17	1518.17	1518.17	1518.17	1518.17	1518.17	1518.17	1518.17	1518.17	1518.17	1518.17	1518.17	1518.17
PARÁM. CAT. - G (m)		2577.53	2577.53	2577.53	2577.53	2577.53	2577.53	2577.53	2577.53	2577.53	2577.53	2577.53	2577.53	2577.53	2577.53	2577.53	2577.53
CONDUCTOR	1xIRAM 95/15 ACSR	1xIRAM 95/15 ACSR	1xIRAM 95/15 ACSR	1xIRAM 95/15 ACSR	1xIRAM 95/15 ACSR	1xIRAM 95/15 ACSR	1xIRAM 95/15 ACSR	1xIRAM 95/15 ACSR	1xIRAM 95/15 ACSR	1xIRAM 95/15 ACSR	1xIRAM 95/15 ACSR	1xIRAM 95/15 ACSR	1xIRAM 95/15 ACSR	1xIRAM 95/15 ACSR	1xIRAM 95/15 ACSR	1xIRAM 95/15 ACSR	1xIRAM 95/15 ACSR
CONDUCTOR-G	1xHilo_Guarda_25/7	1xHilo_Guarda_25/7	1xHilo_Guarda_25/7	1xHilo_Guarda_25/7	1xHilo_Guarda_25/7	1xHilo_Guarda_25/7	1xHilo_Guarda_25/7	1xHilo_Guarda_25/7	1xHilo_Guarda_25/7	1xHilo_Guarda_25/7	1xHilo_Guarda_25/7	1xHilo_Guarda_25/7	1xHilo_Guarda_25/7	1xHilo_Guarda_25/7	1xHilo_Guarda_25/7	1xHilo_Guarda_25/7	1xHilo_Guarda_25/7

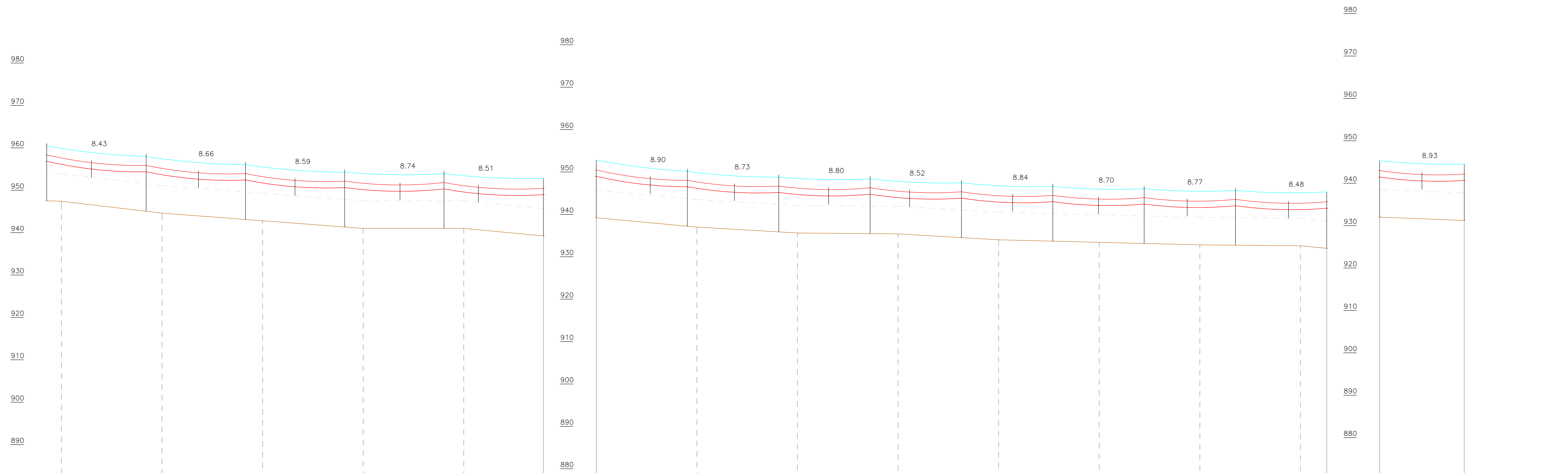

ESTACIÓN	-	95.00	26263.72	95.00	26358.72	95.00	26453.72	95.00	26548.72	75.20	26623.92	26623.92	95.00	26718.92	95.00	26813.92	95.00	26908.92	95.00	27003.92	95.00	27098.92	95.00	27193.92	119.81	27313.73	27313.73	79.93	27393.65	
DISTANCIA PARCIAL (m)		95.00	95.00	95.00	95.00	95.00	95.00	95.00	95.00	75.20	95.00	95.00	95.00	95.00	95.00	95.00	95.00	95.00	95.00	95.00	95.00	95.00	95.00	95.00	119.81	79.93	79.93	79.93		
DISTANCIA ACUMULADA (m)	26168.72	26263.72	26358.72	26453.72	26548.72	26623.92	26623.92	26718.92	26813.92	26908.92	27003.92	27098.92	27193.92	27313.73	27313.73	27393.65														
COTA DE TERRENO (m)	947.40	944.60	942.80	941.00	941.00	939.20	939.20	937.00	935.60	935.40	934.00	933.40	932.80	932.00	932.00	931.20														
TIPO DE TERRENO																														
PROPIETARIO																														

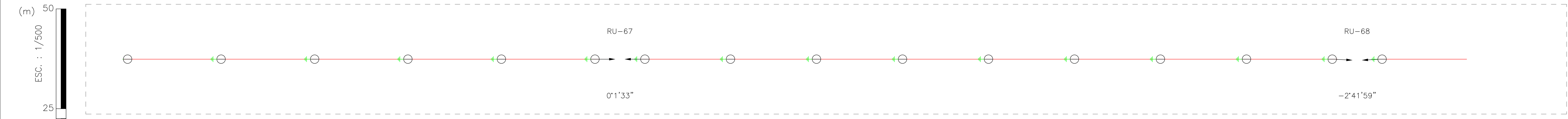

<p>2.22</p>		<p>COMITENTE</p> <p>GOBIERNO DE LA PROVINCIA DE SALTA MINISTERIO DE INFRAESTRUCTURA. GOBIERNO DE SALTA.</p>		<p>OBRA : "TENDIDO DE LINEA DE MEDIA TENSION EN 33 KV CON HILO DE GUARDIA DESDE EL PARQUE INDUSTRIAL Y HASTA LA ENTRADA AL ACCESO POR LA RUTA NAC.º9 A LA LOCALIDAD DEL LA CANDELARIA-EL JARDIN - EL TALA-E603021090356- DSC 0177/21-NIS537113.</p>		<p>DIS. : Ing. MARIO ALFARO</p> <p>REV. :-</p> <p>APR. :-</p> <p>DIB. : Arq. MARIEL ALFARO</p>		<p>DEPARTAMENTO: ROSARIO DE LA FRONTERA</p> <p>PROVINCIA : SALTA</p> <p>DISTRITO : METAN</p> <p>FECHA :</p>									
<p>REV.</p>		<p>DESCRIPCIÓN</p>		<p>DISEÑO</p>		<p>DIBUJO</p>		<p>APROBADO</p>		<p>FECHA</p>		<p>RUTA</p> <p>Distribución de Estructuras</p> <p>PERFIL Y PLANIMETRIA : 26.15 km A 27.39 km</p>		<p>ESCALA :</p> <p>H : 1/2000</p> <p>V : 1/500</p>		<p>PLANO : 22/28</p> <p>01-L.M.T.33 KV</p>	

NÚMERO DE ESTRUCTURA	303	304	304	305	306	307	308	309	310	311	312	313	314	315	316	317
ARMADO PRINCIPAL	RA 0 A 30	RA 0 A 30	RA 0 A 30	SUSPENSION SIMPLE	SUSPENSION SIMPLE	SUSPENSION SIMPLE	SUSPENSION SIMPLE	SUSPENSION SIMPLE	SUSPENSION SIMPLE	SUSPENSION SIMPLE	SUSPENSION SIMPLE	SUSPENSION SIMPLE	SUSPENSION SIMPLE	SUSPENSION SIMPLE	SUSPENSION SIMPLE	SUSPENSION SIM
ACUMULADA (m)	27393.65	27473.93	27473.93	27567.11	27660.61	27754.24	27847.88	27941.53	28035.17	28128.82	28222.76	28316.70	28410.65	28504.59	28598.54	28692.48
VANO VIENTO (m)	80.10	86.73	86.73	93.34	93.56	93.63	93.64	93.64	93.64	93.64	93.79	93.94	93.94	93.94	93.94	93.94
VANO PESO (m)	132.96	21.13	21.13	97.16	106.02	94.09	81.69	128.13	61.92	87.36	102.05	81.19	105.58	115.16	54.61	106.66
SOPORTE	-0-30(1x15/2700/3)	ERA-0-30(1x15/2700/3)	-0-30(1x15/2700/3)	ES(1x15/600/3)	ES(1x15/600/3)	ES(1x15/600/3)	ES(1x15/600/3)	ES(1x15/600/3)	ES(1x15/600/3)	ES(1x15/600/3)	ES(1x15/600/3)	ES(1x15/600/3)	ES(1x15/600/3)	ES(1x15/600/3)	ES(1x15/600/3)	ES(1x15/600/3)
RETENIDAS																
PUESTA A TIERRA	PAT-1C	PAT-1C	PAT-1C	PAT-1C	PAT-1C	PAT-1C	PAT-1C	PAT-1C	PAT-1C	PAT-1C	PAT-1C	PAT-1C	PAT-1C	PAT-1C	PAT-1C	PAT-1C
CIMENTACIÓN	-0-30(1x15/2700/3)	ERA-0-30(1x15/2700/3)	-0-30(1x15/2700/3)	ES(1x15/600/3)	ES(1x15/600/3)	ES(1x15/600/3)	ES(1x15/600/3)	ES(1x15/600/3)	ES(1x15/600/3)	ES(1x15/600/3)	ES(1x15/600/3)	ES(1x15/600/3)	ES(1x15/600/3)	ES(1x15/600/3)	ES(1x15/600/3)	ES(1x15/600/3)
AMORTIGUADORES	-/-	-/-	-/-	-/-	-/-	-/-	-/-	-/-	-/-	-/-	-/-	-/-	-/-	-/-	-/-	-/-
AMORTIGUADORES-G	-/-	-/-	-/-	-/-	-/-	-/-	-/-	-/-	-/-	-/-	-/-	-/-	-/-	-/-	-/-	-/-
VANO HORIZONTAL (m)		80.28		93.18	93.50	93.62	93.64	93.64	93.64	93.64	93.64	93.94	93.94	93.94	93.94	93.94
VANO REGULADOR (m)		80.28		93.76	93.76	93.76	93.76	93.76	93.76	93.76	93.76	93.76	93.76	93.76	93.76	93.76
PARÁMETRO CATENARIA (m)		1518.17		1518.17	1518.17	1518.17	1518.17	1518.17	1518.17	1518.17	1518.17	1518.17	1518.17	1518.17	1518.17	1518.17
PARÁM. CAT. - G (m)		2577.53		2577.53	2577.53	2577.53	2577.53	2577.53	2577.53	2577.53	2577.53	2577.53	2577.53	2577.53	2577.53	2577.53
CONDUCTOR	1xIRAM 95/15 ACSR	1xIRAM 95/15 ACSR	1xIRAM 95/15 ACSR	1xIRAM 95/15 ACSR	1xIRAM 95/15 ACSR	1xIRAM 95/15 ACSR	1xIRAM 95/15 ACSR	1xIRAM 95/15 ACSR	1xIRAM 95/15 ACSR	1xIRAM 95/15 ACSR	1xIRAM 95/15 ACSR	1xIRAM 95/15 ACSR	1xIRAM 95/15 ACSR	1xIRAM 95/15 ACSR	1xIRAM 95/15 ACSR	1xIRAM 95/15 ACSR
CONDUCTOR-G	1xHilo_Guarda_25/7	1xHilo_Guarda_25/7	1xHilo_Guarda_25/7	1xHilo_Guarda_25/7	1xHilo_Guarda_25/7	1xHilo_Guarda_25/7	1xHilo_Guarda_25/7	1xHilo_Guarda_25/7	1xHilo_Guarda_25/7	1xHilo_Guarda_25/7	1xHilo_Guarda_25/7	1xHilo_Guarda_25/7	1xHilo_Guarda_25/7	1xHilo_Guarda_25/7	1xHilo_Guarda_25/7	1xHilo_Guarda_25/7

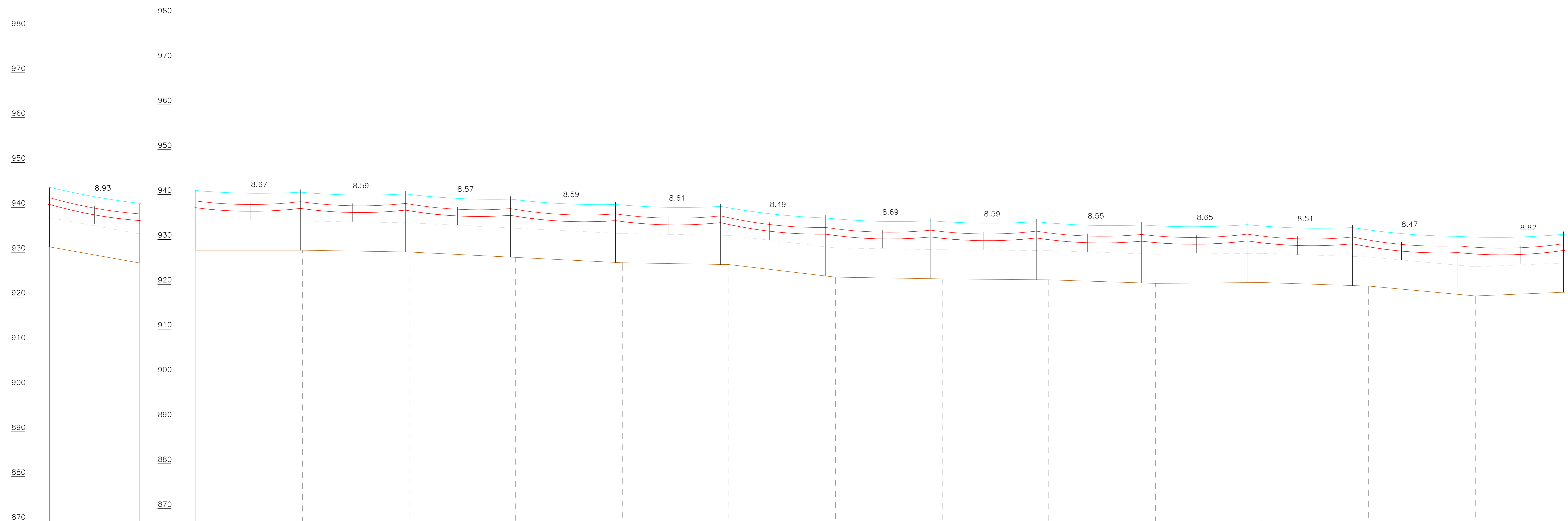

ESTACIÓN	RU-69	RU-70	RU-70	-	-	-	-	-	-	-	-	-	-	-	-	-
DISTANCIA PARCIAL (m)	80.28	27473.93	27473.93	95.00	27568.93	95.00	27663.93	95.00	27758.93	95.00	27853.93	95.00	27948.93	95.00	28043.93	95.00
DISTANCIA ACUMULADA (m)	27393.65	27473.93	27473.93	27568.93	27663.93	27758.93	27853.93	27948.93	28043.93	28138.93	28233.93	28328.93	28423.93	28518.93	28613.93	28708.93
COTA DE TERRENO (m)	931.20	927.60	927.60	927.60	927.20	926.00	924.80	924.40	921.60	921.20	921.00	920.20	920.40	919.60	917.40	916.00
TIPO DE TERRENO																
PROPIETARIO																

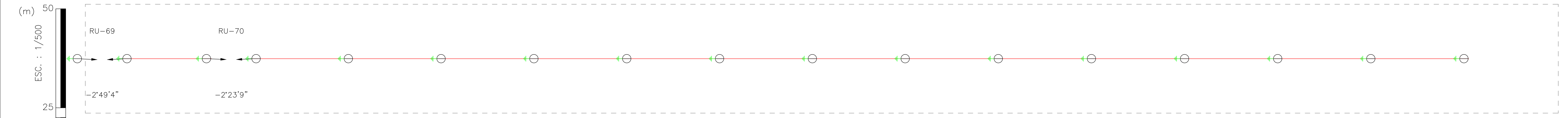

2.23				COMITENTE GOBIERNO DE LA PROVINCIA DE SALTA MINISTERIO DE INFRAESTRUCTURA GOBIERNO DE SALTA.		OBRA : "TENDIDO DE LINEA DE MEDIA TENSION EN 33 KV CON HILO DE GUARDIA DESDE EL PARQUE INDUSTRIAL Y HASTA LA ENTRADA AL ACCESO POR LA RUTA NAC.Nº9 A LA LOCALIDAD DEL LA CANDELARIA-EL JARDIN - EL TALA-E603021090356- DSC 0177/21-NIS537113.		DIS. : Ing. MARIO ALFARO REV. :- APR. :- DIB. : Arq. MARIEL ALFARO		DEPARTAMENTO: ROSARIO DE LA FRONTERA PROVINCIA : SALTA DISTRITO : METAN FECHA : ESCALA : H : 1/2000 V : 1/500		PLANO : 23/28 01-L.M.T.33 KV	
REV.	DESCRIPCIÓN	DISEÑO	DIBUJO	APROBADO	FECHA	RUTA Distribución de Estructuras PERFIL Y PLANIMETRIA : 27.39 km A 28.69 km							

NÚMERO DE ESTRUCTURA	317	318	319	320	320	321	322	323	324	325	326	327	328	329	330	331
ARMADO PRINCIPAL	PENSION SIMPLE	SUSPENSION SIMPLE	SUSPENSION SIMPLE	RETENCION SIMF	TENCION SIMPLE	SUSPENSION SIMPLE	SUSPENSION SIMPLE	SUSPENSION SIMPLE	SUSPENSION SIMPLE	SUSPENSION SIMPLE	SUSPENSION SIMPLE	SUSPENSION SIMPLE	SUSPENSION SIMPLE	SUSPENSION SIMPLE	SUSPENSION SIMPLE	SUSPENSION SIM
ACUMULADA (m)	28692.48	28786.43	28880.37	28973.91	28973.91	29068.00	29161.91	29255.85	29349.80	29443.74	29537.69	29631.56	29725.40	29819.23	29913.07	30006.91
VANO VIENTO (m)	93.94	93.94	93.74	93.81	93.81	94.00	93.93	93.94	93.94	93.94	93.91	93.85	93.84	93.84	93.84	93.50
VANO PESO (m)	106.66	116.62	35.77	121.67	121.67	118.38	94.24	63.03	108.19	85.58	96.37	105.85	77.40	100.70	58.08	91.49
SOPORTE	3(1x15/600/3)	ES(1x15/600/3)	ES(1x15/600/3)	ERRT(1x15/2700)	3(1x15/2700/3)	ES(1x15/600/3)	ES(1x15/600/3)	ES(1x15/600/3)	ES(1x15/600/3)	ES(1x15/600/3)	ES(1x15/600/3)	ES(1x15/600/3)	ES(1x15/600/3)	ES(1x15/600/3)	ES(1x15/600/3)	ES(1x15/600/3)
RETENIDAS																
PUESTA A TIERRA	PAT-1C	PAT-1C	PAT-1C	PAT-1C	PAT-1C	PAT-1C	PAT-1C	PAT-1C	PAT-1C	PAT-1C	PAT-1C	PAT-1C	PAT-1C	PAT-1C	PAT-1C	PAT-1C
CIMENTACIÓN	3(1x15/600/3)	ES(1x15/600/3)	ES(1x15/600/3)	ERRT(1x15/2700)	3(1x15/2700/3)	ES(1x15/600/3)	ES(1x15/600/3)	ES(1x15/600/3)	ES(1x15/600/3)	ES(1x15/600/3)	ES(1x15/600/3)	ES(1x15/600/3)	ES(1x15/600/3)	ES(1x15/600/3)	ES(1x15/600/3)	ES(1x15/600/3)
AMORTIGUADORES	-/-	-/-	-/-	-/-	-/-	-/-	-/-	-/-	-/-	-/-	-/-	-/-	-/-	-/-	-/-	-/-
AMORTIGUADORES-G	-/-	-/-	-/-	-/-	-/-	-/-	-/-	-/-	-/-	-/-	-/-	-/-	-/-	-/-	-/-	-/-
VANO HORIZONTAL (m)		93.94	93.94	93.53		94.09	93.91	93.94	93.94	93.94	93.94	93.87	93.84	93.84	93.84	93.84
VANO REGULADOR (m)		93.76	93.76	93.76		93.77	93.77	93.77	93.77	93.77	93.77	93.77	93.77	93.77	93.77	93.77
PARÁMETRO CATENARIA (m)		1518.17	1518.17	1518.17		1518.17	1518.17	1518.17	1518.17	1518.17	1518.17	1518.17	1518.17	1518.17	1518.17	1518.17
PARÁM. CAT. - G (m)		2577.53	2577.53	2577.53		2577.53	2577.53	2577.53	2577.53	2577.53	2577.53	2577.53	2577.53	2577.53	2577.53	2577.53
CONDUCTOR	1xIRAM 95/15 ACSR	1xIRAM 95/15 ACSR	1xIRAM 95/15 ACSR	1xIRAM 95/15 ACSR	1xIRAM 95/15 ACSR	1xIRAM 95/15 ACSR	1xIRAM 95/15 ACSR	1xIRAM 95/15 ACSR	1xIRAM 95/15 ACSR	1xIRAM 95/15 ACSR	1xIRAM 95/15 ACSR	1xIRAM 95/15 ACSR	1xIRAM 95/15 ACSR	1xIRAM 95/15 ACSR	1xIRAM 95/15 ACSR	1xIRAM 95/15 ACSR
CONDUCTOR-G	1xHilo_Guarda_25/7	1xHilo_Guarda_25/7	1xHilo_Guarda_25/7	1xHilo_Guarda_25/7	1xHilo_Guarda_25/7	1xHilo_Guarda_25/7	1xHilo_Guarda_25/7	1xHilo_Guarda_25/7	1xHilo_Guarda_25/7	1xHilo_Guarda_25/7	1xHilo_Guarda_25/7	1xHilo_Guarda_25/7	1xHilo_Guarda_25/7	1xHilo_Guarda_25/7	1xHilo_Guarda_25/7	1xHilo_Guarda_25/7

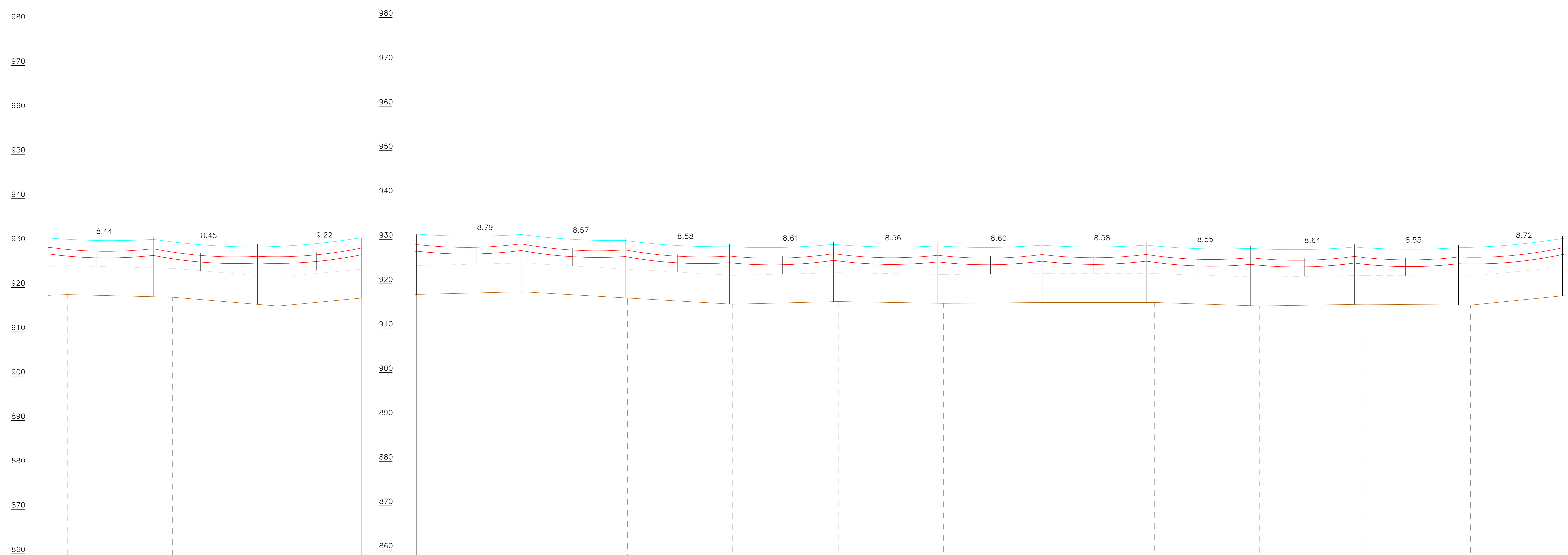

ESTACIÓN	RU-71															
DISTANCIA PARCIAL (m)	-	95.00	-	95.00	-	74.97	-	95.00	-	95.00	-	95.00	-	95.00	-	95.00
DISTANCIA ACUMULADA (m)	28708.93	28803.93	28898.93	28973.91	28973.91	29068.91	29163.91	29258.91	29353.91	29448.91	29543.91	29638.91	29733.91	29828.91	29923.91	30018.91
COTA DE TERRENO (m)	918.40	917.80	915.80	917.60	917.60	918.20	916.80	915.40	916.00	915.60	915.80	915.80	915.00	915.40	915.20	917.00
TIPO DE TERRENO																
PROPIETARIO																

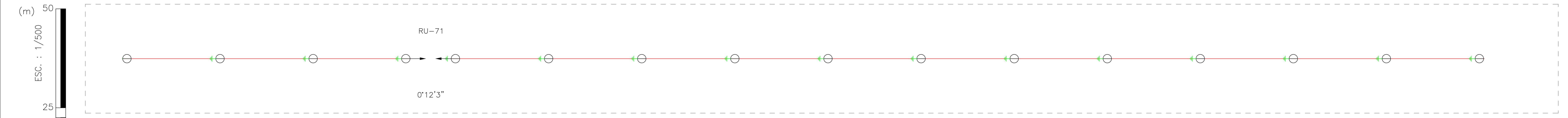

ESC. : 1/500

ESC. : 1/2000 (m)

2.24

REV.	DESCRIPCIÓN	DISEÑO	DIBUJO	APROBADO	FECHA

COMITENTE

GOBIERNO DE LA PROVINCIA DE SALTA
MINISTERIO DE INFRAESTRUCTURA.
GOBIERNO DE SALTA.

OBRA : "TENDIDO DE LINEA DE MEDIA TENSION EN 33 KV CON HILO DE GUARDIA DESDE EL PARQUE INDUSTRIAL Y HASTA LA ENTRADA AL ACCESO POR LA RUTA NAC.º9 A LA LOCALIDAD DEL LA CANDELARIA-EL JARDIN - EL TALA-E603021090356- DSC 0177/21-NIS5337113.

RUTA

Distribución de Estructuras

PERFIL Y PLANIMETRIA : 28.69 km A 30.01 km

DIS. : Ing. MARIO ALFARO

REV. :-

APR. :-

DIB. : Arq. MARIEL ALFARO

DEPARTAMENTO: ROSARIO DE LA FRONTERA

PROVINCIA : SALTA

DISTRITO : METAN

FECHA :

ESCALA :
H : 1/2000
V : 1/500

PLANO : 24/28
01-L.M.T.33 KV

NÚMERO DE ESTRUCTURA	331	332	333	334	335	336	336	337	338	339	340	341	342	343	344	345
ARMADO PRINCIPAL	PENSION SIMPLE	SUSPENSION SIMPLE	SUSPENSION SIMPLE	SUSPENSION SIMPLE	SUSPENSION SIMPLE	RETENCION SIMF	TENCION SIMPLE	SUSPENSION SIMPLE	SUSPENSION SIMPLE	SUSPENSION SIMPLE	SUSPENSION SIMPLE	SUSPENSION SIMPLE	SUSPENSION SIMPLE	SUSPENSION SIMPLE	SUSPENSION SIMPLE	SUSPENSION SIM
ACUMULADA (m)	30006.91	30100.07	30193.46	30286.85	30380.46	30473.88	30473.88	30568.04	30662.08	30756.31	30850.67	30944.86	31039.06	31133.42	31227.62	31321.81
VANO VIENTO (m)	93.50	93.28	93.39	93.50	93.52	93.79	93.79	94.10	94.13	94.30	94.28	94.20	94.28	94.28	94.20	94.20
VANO PESO (m)	91.49	110.02	82.89	59.51	103.13	116.39	116.39	99.50	109.92	79.06	81.50	139.64	138.77	54.43	139.32	100.55
SOPORTE	3(1x15/600/3)	ES(1x15/600/3)	ES(1x15/600/3)	ES(1x15/600/3)	ES(1x15/600/3)	ERRT(1x15/2700	T(1x15/2700/3)	ES(1x15/600/3)	ES(1x15/600/3)	ES(1x15/600/3)	ES(1x15/600/3)	ES(1x15/600/3)	ES(1x15/600/3)	ES(1x15/600/3)	ES(1x15/600/3)	ES(1x15/600/3)
RETENIDAS																
PUESTA A TIERRA	PAT-1C	PAT-1C	PAT-1C	PAT-1C	PAT-1C	PAT-1C	PAT-1C	PAT-1C	PAT-1C	PAT-1C	PAT-1C	PAT-1C	PAT-1C	PAT-1C	PAT-1C	PAT-1C
CIMENTACIÓN	3(1x15/600/3)	ES(1x15/600/3)	ES(1x15/600/3)	ES(1x15/600/3)	ES(1x15/600/3)	ERRT(1x15/2700	T(1x15/2700/3)	ES(1x15/600/3)	ES(1x15/600/3)	ES(1x15/600/3)	ES(1x15/600/3)	ES(1x15/600/3)	ES(1x15/600/3)	ES(1x15/600/3)	ES(1x15/600/3)	ES(1x15/600/3)
AMORTIGUADORES	-/-	-/-	-/-	-/-	-/-	-/-	-/-	-/-	-/-	-/-	-/-	-/-	-/-	-/-	-/-	-/-
AMORTIGUADORES-G	-/-	-/-	-/-	-/-	-/-	-/-	-/-	-/-	-/-	-/-	-/-	-/-	-/-	-/-	-/-	-/-
VANO HORIZONTAL (m)		93.16	93.39	93.39	93.61	93.43		94.16	94.04	94.23	94.36	94.20	94.20	94.36	94.20	94.20
VANO REGULADOR (m)		93.77	93.77	93.77	93.77	93.77		94.28	94.28	94.28	94.28	94.28	94.28	94.28	94.28	94.28
PARÁMETRO CATENARIA (m)		1518.17	1518.17	1518.17	1518.17	1518.17		1518.17	1518.17	1518.17	1518.17	1518.17	1518.17	1518.17	1518.17	1518.17
PARÁM. CAT. - G (m)		2577.53	2577.53	2577.53	2577.53	2577.53		2577.53	2577.53	2577.53	2577.53	2577.53	2577.53	2577.53	2577.53	2577.53
CONDUCTOR	1xIRAM 95/15 ACSR	1xIRAM 95/15 ACSR	1xIRAM 95/15 ACSR	1xIRAM 95/15 ACSR	1xIRAM 95/15 ACSR	1xIRAM 95/15 ACSR	1xIRAM 95/15 ACSR	1xIRAM 95/15 ACSR	1xIRAM 95/15 ACSR	1xIRAM 95/15 ACSR	1xIRAM 95/15 ACSR	1xIRAM 95/15 ACSR	1xIRAM 95/15 ACSR	1xIRAM 95/15 ACSR	1xIRAM 95/15 ACSR	1xIRAM 95/15 ACSR
CONDUCTOR-G	1xHilo_Guarda_25/7	1xHilo_Guarda_25/7	1xHilo_Guarda_25/7	1xHilo_Guarda_25/7	1xHilo_Guarda_25/7	1xHilo_Guarda_25/7	1xHilo_Guarda_25/7	1xHilo_Guarda_25/7	1xHilo_Guarda_25/7	1xHilo_Guarda_25/7	1xHilo_Guarda_25/7	1xHilo_Guarda_25/7	1xHilo_Guarda_25/7	1xHilo_Guarda_25/7	1xHilo_Guarda_25/7	1xHilo_Guarda_25/7

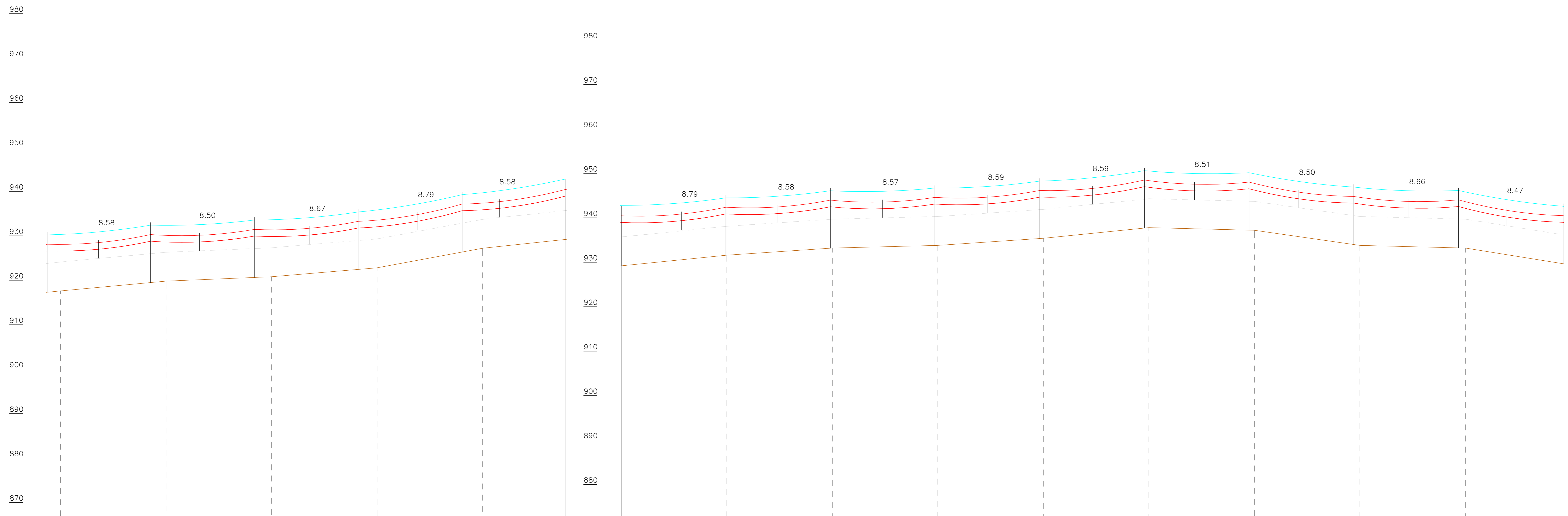

ESTACIÓN	RU-72																	
DISTANCIA PARCIAL (m)	95.00	95.00	95.00	95.00	95.00	74.98	95.00	95.00	95.00	95.00	95.00	95.00	95.00	95.00	95.00	95.00	95.00	95.00
DISTANCIA ACUMULADA (m)	30018.91	30113.91	30208.91	30303.91	30398.91	30473.88	30473.88	30568.88	30663.88	30758.88	30853.88	30948.88	31043.88	31138.88	31233.88	31328.88		
COTA DE TERRENO (m)	917.60	919.80	920.80	922.80	927.20	929.20	929.20	931.60	933.20	933.80	935.40	937.80	937.20	933.80	933.20	929.40		
TIPO DE TERRENO																		
PROPIETARIO																		

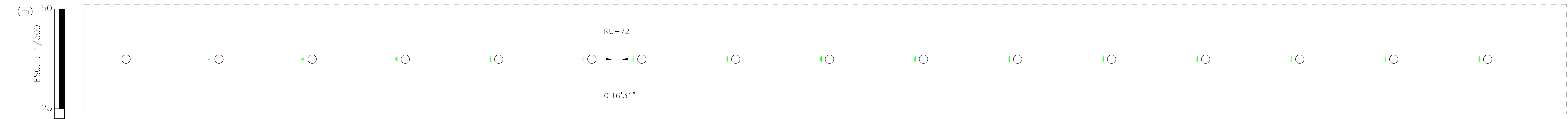

2.25	COMITENTE GOBIERNO DE LA PROVINCIA DE SALTA MINISTERIO DE INFRAESTRUCTURA. GOBIERNO DE SALTA.			OBRA: "TENDIDO DE LINEA DE MEDIA TENSION EN 33 KV CON HILO DE GUARDIA DESDE EL PARQUE INDUSTRIAL Y HASTA LA ENTRADA AL ACCESO POR LA RUTA NAC.Nº9 A LA LOCALIDAD DEL LA CANDELARIA-EL JARDIN - EL TALA-E603021090356- DSC 0177/21-NIS5337113.		DIS. : Ing. MARIO ALFARO REV. :-		DEPARTAMENTO: ROSARIO DE LA FRONTERA PROVINCIA : SALTA DISTRITO : METAN FECHA :	
	ESCALA : H : 1/2000 V : 1/500		PLANO : 25/28 01-L.M.T.33 KV		RUTA Distribución de Estructuras PERFIL Y PLANIMETRIA : 30.01 km A 31.32 km		APR. :- DIB. : Arq. MARIEL ALFARO		
REV.	DESCRIPCIÓN	DISEÑO	DIBUJO	APROBADO	FECHA				

NÚMERO DE ESTRUCTURA	345	346	347	348	348	349	349	350	350	351	352	353	353	354	354	355	355	356	356	357
ARMADO PRINCIPAL	PENSION SIMPLE	SUSPENSION SIMPLE	SUSPENSION SIMPLE	RA O A 30	RA O A 30	RA O A 30	RA O A 30	RA O A 30	RA O A 30	SUSPENSION SIMPLE	SUSPENSION SIMPLE	RA O A 30	RA O A 30	RA O A 30	RA O A 30	RA O A 30	RA O A 30	RA O A 30	RA O A 30	RA O A 30
ACUMULADA (m)	31321.81	31416.01	31510.20	31604.68	31604.68	31684.14	31684.14	31764.12	31764.12	31834.45	31904.27	31974.56	31974.56	32054.93	32054.93	32134.00	32134.00	32214.48	32214.48	32294.53
VANO VIENTO (m)	94.20	94.20	94.34	86.97	86.97	79.72	79.72	75.15	75.15	70.08	70.06	75.33	75.33	79.72	79.72	79.77	79.77	80.27	80.27	79.88
VANO PESO (m)	100.55	56.38	113.11	61.45	61.45	98.57	98.57	72.40	72.40	50.30	73.19	113.42	113.42	34.60	34.60	75.80	75.80	87.89	87.89	83.75
SOPORTE	3(1x15/600/3)	ES(1x15/600/3)	ES(1x15/600/3)	ERA-0-30(1x15/2700/3)	-0-30(1x15/2700/3)	ERA-0-30(1x15/2700/3)	-0-30(1x15/2700/3)	ERA-0-30(1x15/2700/3)	-0-30(1x15/2700/3)	ES(1x15/600/3)	ES(1x15/600/3)	ERA-0-30(1x15/2700/3)	-0-30(1x15/2700/3)	ERA-0-30(1x15/2700/3)	-0-30(1x15/2700/3)	ERA-0-30(1x15/2700/3)	-0-30(1x15/2700/3)	ERA-0-30(1x15/2700/3)	-0-30(1x15/2700/3)	ERA-0-30(1x15/2700/3)
RETENIDAS																				
PUESTA A TIERRA	PAT-1C	PAT-1C	PAT-1C	PAT-1C	PAT-1C	PAT-1C	PAT-1C	PAT-1C	PAT-1C	PAT-1C	PAT-1C	PAT-1C	PAT-1C	PAT-1C	PAT-1C	PAT-1C	PAT-1C	PAT-1C	PAT-1C	PAT-1C
CIMENTACIÓN	3(1x15/600/3)	ES(1x15/600/3)	ES(1x15/600/3)	ERA-0-30(1x15/2700/3)	-0-30(1x15/2700/3)	ERA-0-30(1x15/2700/3)	-0-30(1x15/2700/3)	ERA-0-30(1x15/2700/3)	-0-30(1x15/2700/3)	ES(1x15/600/3)	ES(1x15/600/3)	ERA-0-30(1x15/2700/3)	-0-30(1x15/2700/3)	ERA-0-30(1x15/2700/3)	-0-30(1x15/2700/3)	ERA-0-30(1x15/2700/3)	-0-30(1x15/2700/3)	ERA-0-30(1x15/2700/3)	-0-30(1x15/2700/3)	ERA-0-30(1x15/2700/3)
AMORTIGUADORES	-/-	-/-	-/-	-/-	-/-	-/-	-/-	-/-	-/-	-/-	-/-	-/-	-/-	-/-	-/-	-/-	-/-	-/-	-/-	-/-
AMORTIGUADORES-G	-/-	-/-	-/-	-/-	-/-	-/-	-/-	-/-	-/-	-/-	-/-	-/-	-/-	-/-	-/-	-/-	-/-	-/-	-/-	-/-
VANO HORIZONTAL (m)		94.20	94.20	94.48		79.46		79.98		70.33		69.82		70.29		80.38		79.07		80.48
VANO REGULADOR (m)		94.28	94.28	94.28		79.46		79.98		70.16		70.16		70.16		80.38		79.07		80.48
PARÁMETRO CATENARIA (m)		1518.17	1518.17	1518.17		1518.17		1518.17		1518.17		1518.17		1518.17		1518.17		1518.17		1518.17
PARÁM. CAT. - G (m)		2577.53	2577.53	2577.53		2577.53		2577.53		2577.53		2577.53		2577.53		2577.53		2577.53		2577.53
CONDUCTOR	1xIRAM 95/15 ACSR	1xIRAM 95/15 ACSR	1xIRAM 95/15 ACSR			1xIRAM 95/15 ACSR		1xIRAM 95/15 ACSR		1xIRAM 95/15 ACSR	1xIRAM 95/15 ACSR	1xIRAM 95/15 ACSR	1xIRAM 95/15 ACSR	1xIRAM 95/15 ACSR	1xIRAM 95/15 ACSR	1xIRAM 95/15 ACSR	1xIRAM 95/15 ACSR	1xIRAM 95/15 ACSR	1xIRAM 95/15 ACSR	
CONDUCTOR-G	1xHilo_Guarda_25/7	1xHilo_Guarda_25/7	1xHilo_Guarda_25/7			1xHilo_Guarda_25/7		1xHilo_Guarda_25/7		1xHilo_Guarda_25/7	1xHilo_Guarda_25/7	1xHilo_Guarda_25/7	1xHilo_Guarda_25/7	1xHilo_Guarda_25/7	1xHilo_Guarda_25/7	1xHilo_Guarda_25/7	1xHilo_Guarda_25/7	1xHilo_Guarda_25/7	1xHilo_Guarda_25/7	

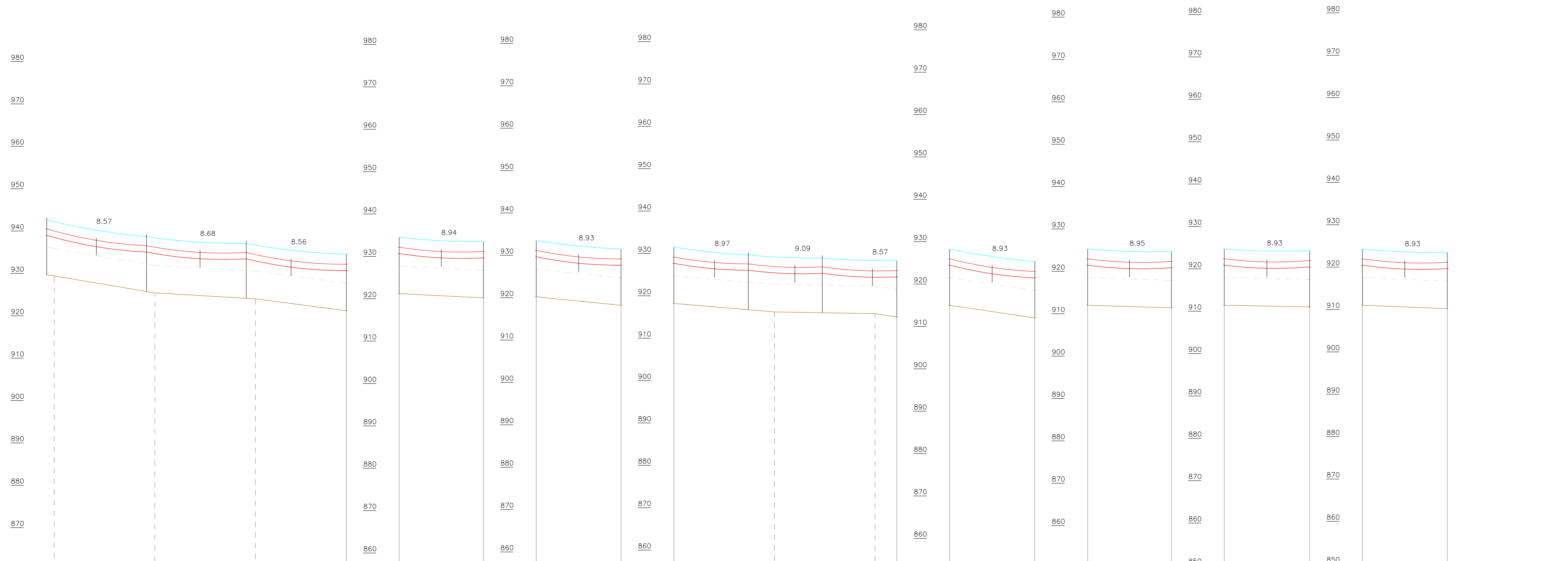

ESTACIÓN	-	-	-	RU-73	RU-73	RU-74	RU-74	RU-75	RU-75	-	RU-76	RU-76	RU-77	RU-77	RU-78	RU-78	RU-79	RU-79	RU-80
DISTANCIA PARCIAL (m)	95.00	95.00	85.80	79.46	79.98	79.98	79.98	95.00	115.44		80.38	80.38	79.07	79.07	80.48	80.48	80.05	80.05	
DISTANCIA ACUMULADA (m)	31328.88	31423.88	31518.88	31604.68	31604.68	31684.14	31684.14	31764.12	31764.12	31859.12	31974.56	31974.56	32054.93	32054.93	32134.00	32134.00	32214.48	32214.48	32294.53
COTA DE TERRENO (m)	929.40	925.40	924.00	921.20	921.20	920.20	920.20	918.20	918.20	916.20	915.00	915.00	912.00	912.00	911.40	911.40	911.00	911.00	910.20
TIPO DE TERRENO																			
PROPIETARIO																			

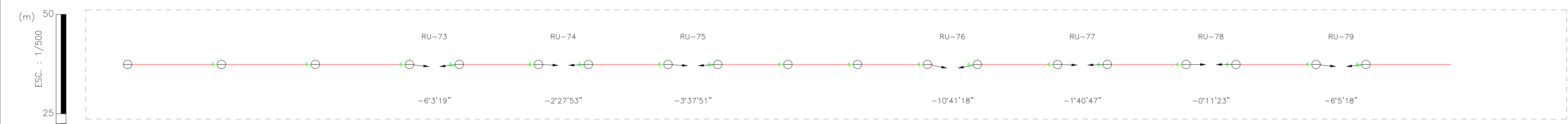

<p>2.26</p>				<p>COMITENTE</p> <p>GOBIERNO DE LA PROVINCIA DE SALTA MINISTERIO DE INFRAESTRUCTURA. GOBIERNO DE SALTA.</p>		<p>OBRA : "TENDIDO DE LINEA DE MEDIA TENSION EN 33 KV CON HILO DE GUARDIA DESDE EL PARQUE INDUSTRIAL Y HASTA LA ENTRADA AL ACCESO POR LA RUTA NAC.Nº9 A LA LOCALIDAD DEL LA CANDELARIA-EL JARDIN - EL TALA-E603021090356- DSC 0177/21-NIS537113.</p>		<p>DIS. : Ing. MARIO ALFARO</p> <p>REV. :-</p>		<p>DEPARTAMENTO: ROSARIO DE LA FRONTERA</p> <p>PROVINCIA : SALTA</p> <p>DISTRITO : METAN</p> <p>FECHA :</p>	
<p>REV. DESCRIPCIÓN DISEÑO DIBUJO APROBADO FECHA</p>				<p>RUTA</p> <p>Distribución de Estructuras</p> <p>PERFIL Y PLANIMETRIA : 31.32 km A 32.29 km</p>		<p>APR. :-</p> <p>DIB. : Arq. MARIEL ALFARO</p>		<p>ESCALA :</p> <p>H : 1/2000</p> <p>V : 1/500</p>		<p>PLANO : 26/28</p> <p>01-L.M.T.33 KV</p>	

NÚMERO DE ESTRUCTURA	357	358	358	359	359	360	361	362	363	364	365	366	367	368	369	370
ARMADO PRINCIPAL	RA O A 30	RA O A 30	RA O A 30	RA O A 30	RA O A 30	SUSPENSION SIMPLE	SUSPENSION SIMPLE	SUSPENSION SIMPLE	SUSPENSION SIMPLE	SUSPENSION SIMPLE	SUSPENSION SIMPLE	SUSPENSION SIMPLE	SUSPENSION SIMPLE	SUSPENSION SIMPLE	SUSPENSION SIMPLE	RA O A 30
ACUMULADA (m)	32294.53	32374.24	32374.24	32454.33	32454.33	32547.53	32641.22	32735.11	32829.06	32923.00	33016.95	33110.89	33204.54	33298.18	33391.22	33484.39
VANO VIENTO (m)	79.88	79.90	79.90	86.64	86.64	93.44	93.79	93.92	93.94	93.94	93.94	93.79	93.64	93.34	93.10	87.47
VANO PESO (m)	83.75	98.76	98.76	57.58	57.58	137.99	48.38	86.23	123.82	89.78	61.13	111.39	109.97	75.33	95.51	90.84
SOPORTE	-0-30(1x15/2700/3)	ERA-0-30(1x15/2700/3)	-0-30(1x15/2700/3)	ERA-0-30(1x15/2700/3)	-0-30(1x15/2700/3)	ES(1x15/600/3)	ES(1x15/600/3)	ES(1x15/600/3)	ES(1x15/600/3)	ES(1x15/600/3)	ES(1x15/600/3)	ES(1x15/600/3)	ES(1x15/600/3)	ES(1x15/600/3)	ES(1x15/600/3)	ERA-0-30(1x15/2700/3)
RETENIDAS																
PUESTA A TIERRA	PAT-1C	PAT-1C	PAT-1C	PAT-1C	PAT-1C	PAT-1C	PAT-1C	PAT-1C	PAT-1C	PAT-1C	PAT-1C	PAT-1C	PAT-1C	PAT-1C	PAT-1C	PAT-1C
CIMENTACIÓN	-0-30(1x15/2700/3)	ERA-0-30(1x15/2700/3)	-0-30(1x15/2700/3)	ERA-0-30(1x15/2700/3)	-0-30(1x15/2700/3)	ES(1x15/600/3)	ES(1x15/600/3)	ES(1x15/600/3)	ES(1x15/600/3)	ES(1x15/600/3)	ES(1x15/600/3)	ES(1x15/600/3)	ES(1x15/600/3)	ES(1x15/600/3)	ES(1x15/600/3)	ERA-0-30(1x15/2700/3)
AMORTIGUADORES	-/-	-/-	-/-	-/-	-/-	-/-	-/-	-/-	-/-	-/-	-/-	-/-	-/-	-/-	-/-	-/-
AMORTIGUADORES-G	-/-	-/-	-/-	-/-	-/-	-/-	-/-	-/-	-/-	-/-	-/-	-/-	-/-	-/-	-/-	-/-
VANO HORIZONTAL (m)		79.70		80.09		93.20		93.69		93.94		93.94		93.64		93.16
VANO REGULADOR (m)		79.70		80.09		93.66		93.66		93.66		93.66		93.66		93.66
PARÁMETRO CATENARIA (m)		1518.17		1518.17		1518.17		1518.17		1518.17		1518.17		1518.17		1518.17
PARÁM. CAT. - G (m)		2577.53		2577.53		2577.53		2577.53		2577.53		2577.53		2577.53		2577.53
CONDUCTOR	1xIRAM 95/15 ACSR	1xIRAM 95/15 ACSR	1xIRAM 95/15 ACSR	1xIRAM 95/15 ACSR	1xIRAM 95/15 ACSR	1xIRAM 95/15 ACSR	1xIRAM 95/15 ACSR	1xIRAM 95/15 ACSR	1xIRAM 95/15 ACSR	1xIRAM 95/15 ACSR	1xIRAM 95/15 ACSR	1xIRAM 95/15 ACSR	1xIRAM 95/15 ACSR	1xIRAM 95/15 ACSR	1xIRAM 95/15 ACSR	1xIRAM 95/15 ACSR
CONDUCTOR-G	1xHilo_Guarda_25/7	1xHilo_Guarda_25/7	1xHilo_Guarda_25/7	1xHilo_Guarda_25/7	1xHilo_Guarda_25/7	1xHilo_Guarda_25/7	1xHilo_Guarda_25/7	1xHilo_Guarda_25/7	1xHilo_Guarda_25/7	1xHilo_Guarda_25/7	1xHilo_Guarda_25/7	1xHilo_Guarda_25/7	1xHilo_Guarda_25/7	1xHilo_Guarda_25/7	1xHilo_Guarda_25/7	1xHilo_Guarda_25/7

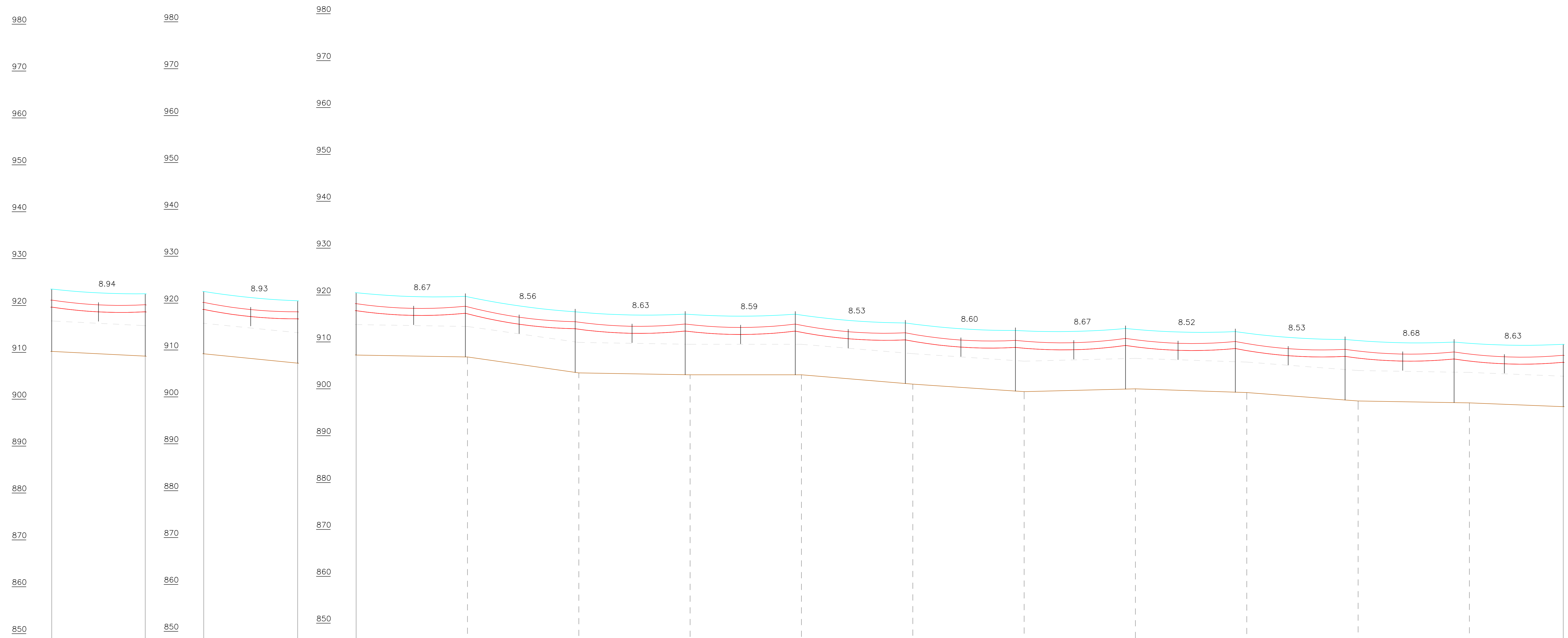

ESTACIÓN	RU-80	RU-81	RU-81	RU-82	RU-82												RU-83											
DISTANCIA PARCIAL (m)	79.70	32374.24	32374.24	80.09	32454.33	32454.33	95.00	32549.33	95.00	32644.33	95.00	32739.33	95.00	32834.33	95.00	32929.33	95.00	33024.33	95.00	33119.33	95.00	33214.33	95.00	33309.33	95.00	33404.33	80.06	33484.39
DISTANCIA ACUMULADA (m)	32294.53	32374.24	32374.24	32454.33	32454.33	32549.33	32644.33	32739.33	32834.33	32929.33	33024.33	33119.33	33214.33	33309.33	33404.33	33484.39												
COTA DE TERRENO (m)	910.20	909.20	909.20	907.20	907.20	906.80	903.40	903.00	903.00	901.00	899.40	900.00	899.20	897.40	897.00	896.20												
TIPO DE TERRENO																												
PROPIETARIO																												

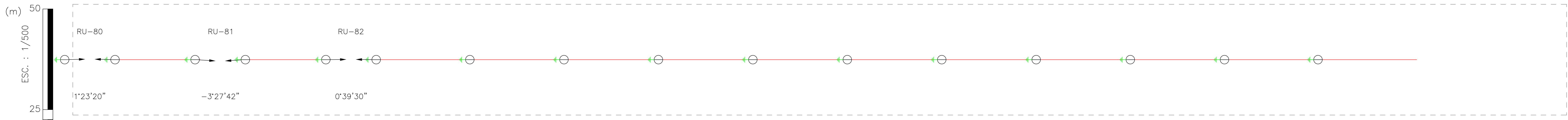

2.27				COMITENTE GOBIERNO DE LA PROVINCIA DE SALTA MINISTERIO DE INFRAESTRUCTURA. GOBIERNO DE SALTA.		OBRA : "TENDIDO DE LINEA DE MEDIA TENSION EN 33 KV CON HILO DE GUARDIA DESDE EL PARQUE INDUSTRIAL Y HASTA LA ENTRADA AL ACCESO POR LA RUTA NAC.º9 A LA LOCALIDAD DEL LA CANDELARIA-EL JARDIN - EL TALA-E603021090356- DSC 0177/21-NIS537113.		DIS. : Ing. MARIO ALFARO REV. :- APR. :- DIB. : Arq. MARIEL ALFARO		DEPARTAMENTO: ROSARIO DE LA FRONTERA PROVINCIA : SALTA DISTRITO : METAN FECHA :	
RUTA Distribución de Estructuras PERFIL Y PLANIMETRIA : 32.29 km A 33.48 km				ESCALA : H : 1/2000 V : 1/500		PLANO : 27/28 01-L.M.T.33 KV					
REV.	DESCRIPCIÓN	DISÑO	DIBUJO	APROBADO	FECHA						

NÚMERO DE ESTRUCTURA	370	371	371	372
ARMADO PRINCIPAL	RA 0 A 30	RA 60 A 90	RA 60 A 90	TERMINAL
ACUMULADA (m)	33484.39	33566.17	33566.17	33605.28
VANO VIENTO (m)	87.47	60.44	60.44	19.56
VANO PESO (m)	90.84	18.43	18.43	46.73
SOPORTE	-0-30(1+15/2700/3)	ERA-0-30(1+15/2700/3)	30(1+15/2700/3)	ERT(2+15/800/3)
RETENIDAS				
PUESTA A TIERRA	PAT-1C	PAT-1C	PAT-1C	PAT-1C
CIMENTACIÓN	-0-30(1+15/2700/3)	ERA-0-30(1+15/2700/3)	30(1+15/2700/3)	ERT(2+15/800/3)
AMORTIGUADORES	-/-	-/-	-/-	-/-
AMORTIGUADORES-G	-/-	-/-	-/-	-/-
VANO HORIZONTAL (m)	81.78		39.11	0.00
VANO REGULADOR (m)	81.78		39.11	0.00
PARÁMETRO CATENARIA (m)	1518.17		1518.17	
PARÁM. CAT. - G (m)	2577.53		2577.53	
CONDUCTOR	1xIRAM 95/15 ACSR 1		1xIRAM 95/15 ACSR	
CONDUCTOR-G	1xHilo_Guarda_25/7 1		1xHilo_Guarda_25/7	

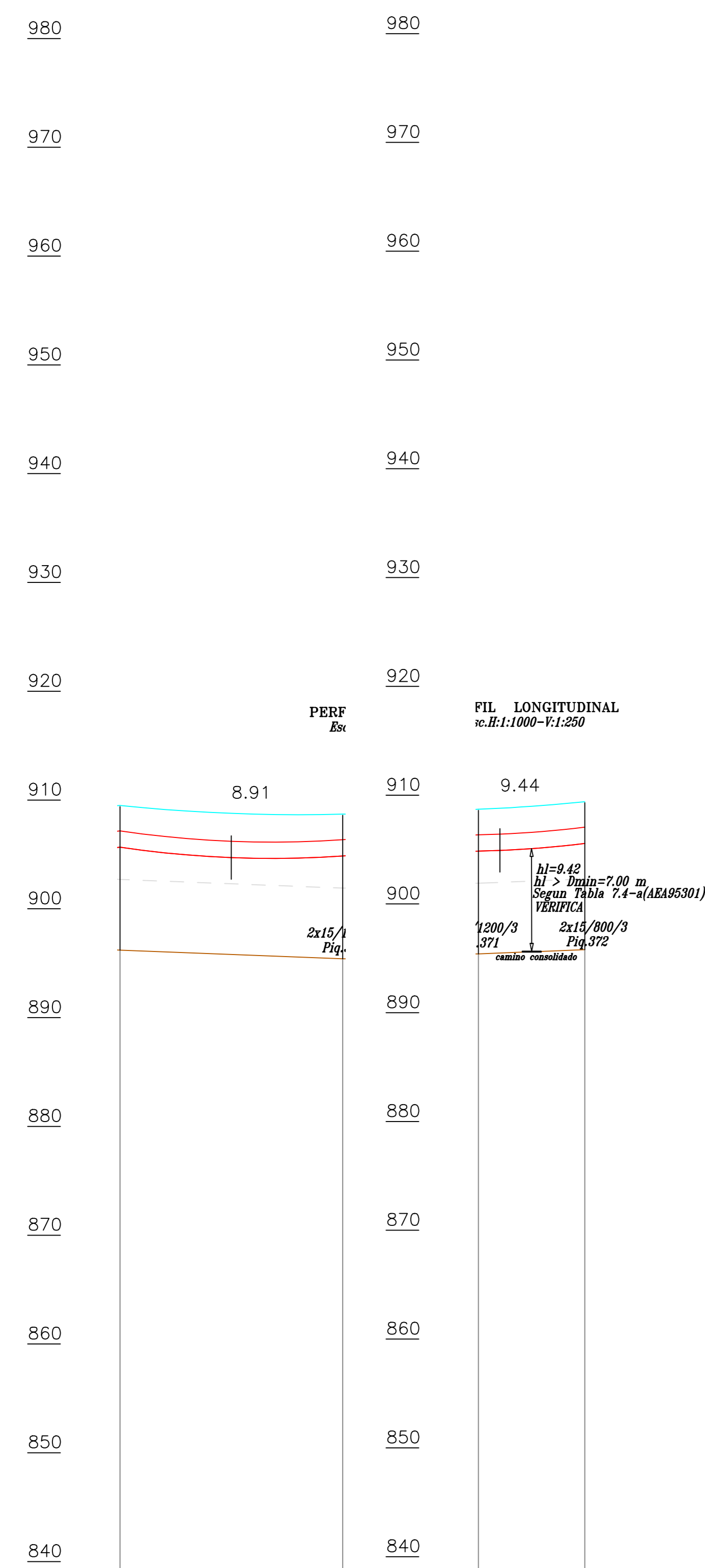

ESTACIÓN	RU-83	RU-84	RU-84	RU-85
DISTANCIA PARCIAL (m)	81.78	31	39.11	
DISTANCIA ACUMULADA (m)	33484.39	33566.17	33566.17	33605.28
COTA DE TERRENO (m)	896.20	895.40	895.40	895.80
TIPO DE TERRENO				
PROPIETARIO				

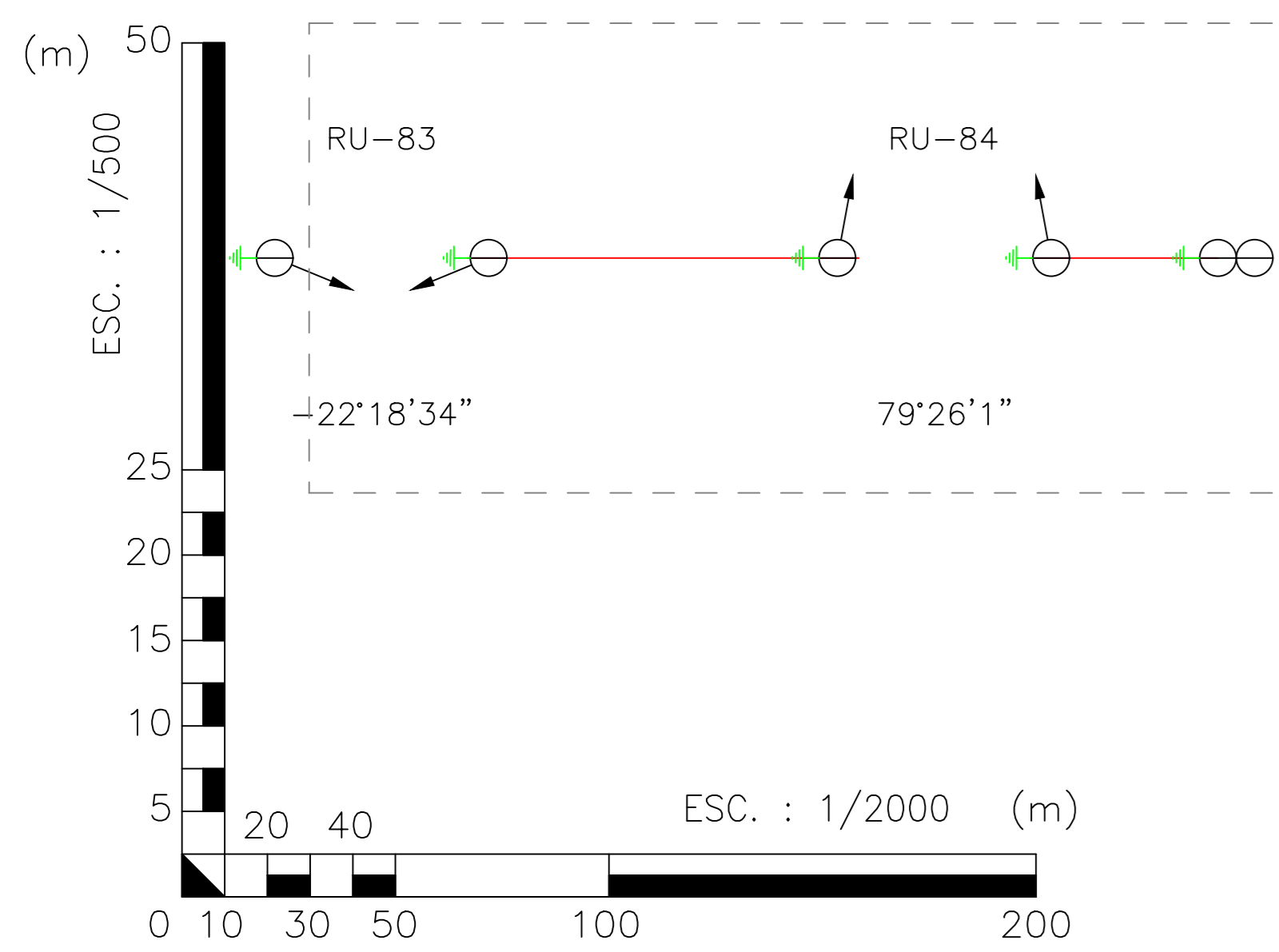

2.28				
REV.	DESCRIPCIÓN	DISEÑO	DIBUJO	APROBADO

COMITENTE
GOBIERNO DE LA PROVINCIA DE SALTA
MINISTERIO DE INFRAESTRUCTURA.
GOBIERNO DE SALTA.

OBRA "TENDIDO DE LINEA DE MEDIA TENSION EN 33 KV CON HILO DE GUARDIA DESDE EL PARQUE INDUSTRIAL Y HASTA LA ENTRADA AL ACCESO POR LA RUTA NAC.Nº9 A LA LOCALIDAD DEL LA CANDELARIA-EL JARDIN - EL TALA-E603021090356- DSC 0177/21-NIS5337113.

RUTA
Distribución de Estructuras
PERFIL Y PLANIMETRÍA : 33.48 km A 33.61 km

DIS. : Ing. MARIO ALFARO
REV. : -
APR. : -
DIB. : Arq. MARIEL ALFARO

DEPARTAMENTO: ROSARIO DE LA FRONTERA
PROVINCIA : SALTA
DISTRITO : METAN
FECHA :

ESCALA :
H : 1/2000
V : 1/500
PLANO : 28/28
01-L.M.T.33 KV

Latitud 26° 6'8.25"S- Long.65° 9'49.79"O

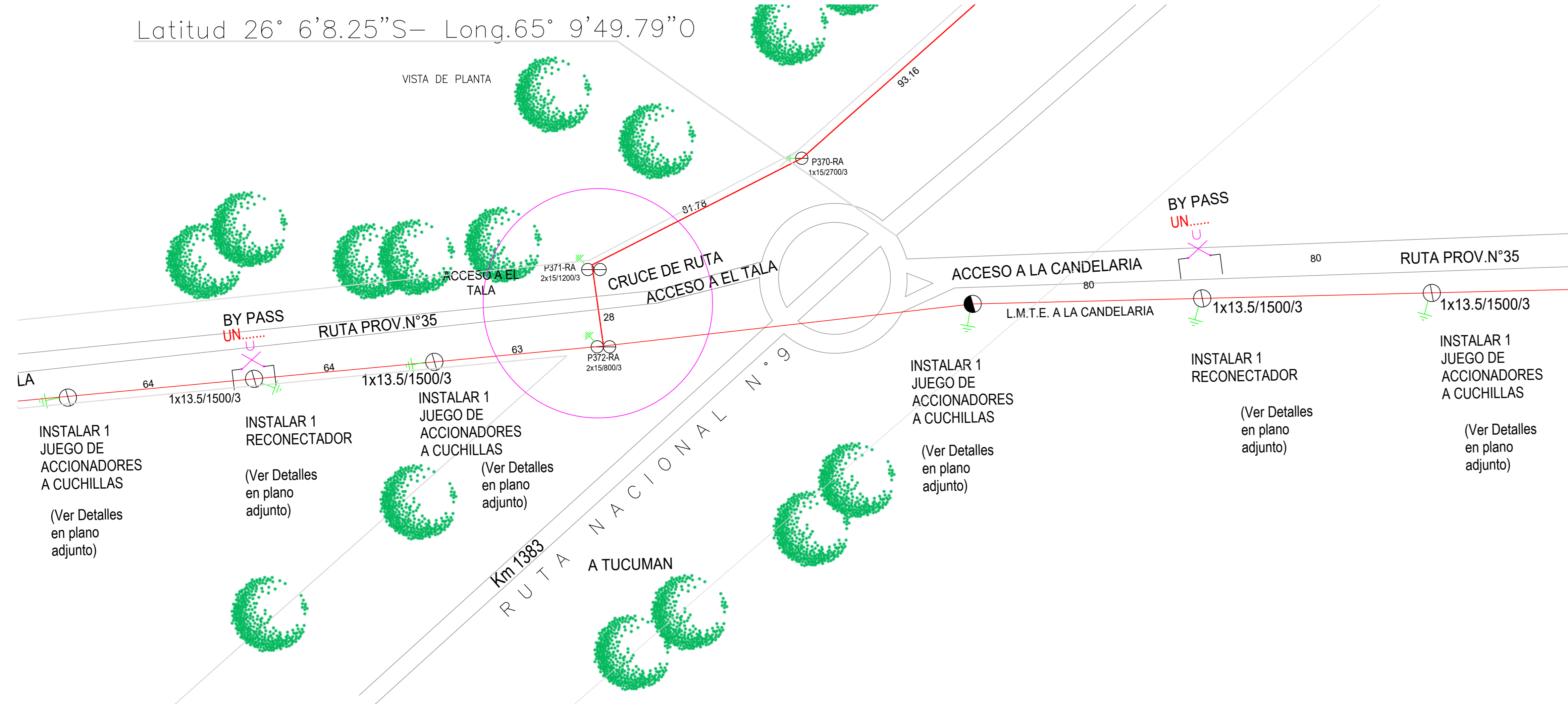

CROQUIS DE UBICACION

E:TOSHIBA EXT01 PROYECTOS A EJECUTAR AÑO 2019|PABLO MARTOS|ALIADIDAD DE LA PROVINCIA|CROQUIS D

REFERENCIAS

- Columna H'A/V'-Segun calculo-Proyectada.
- Columna H'A/V"EXISTENTE.
- Línea M.T.33 KV-Existente.
- Tema N°1 Conductores Al.Ac.-3x(1x95/15 mm2) (RAM2187).
- Tema N°2 Conductores Al.Ac.-3x(1x95/15 mm2) (RAM2187).

INSTALAR 1 JUEGO DE ACCIONADORES A CUCHILLAS
(Ver Detalles en plano adjunto)

INSTALAR 1 RECONECTOR
(Ver Detalles en plano adjunto)

INSTALAR 1 JUEGO DE ACCIONADORES A CUCHILLAS
(Ver Detalles en plano adjunto)

INSTALAR 1 JUEGO DE ACCIONADORES A CUCHILLAS
(Ver Detalles en plano adjunto)

INSTALAR 1 RECONECTOR
(Ver Detalles en plano adjunto)

INSTALAR 1 JUEGO DE ACCIONADORES A CUCHILLAS
(Ver Detalles en plano adjunto)



SITUACION PROYECTADA DEL CRUCE DE RUTA PROVINCIAL N°35 CON L.M.T.33 KV. FRENTE A ROTONDA DE ACSESO A PUEBLO DE EL TALA y A LA CANDELARIA.

TABLA DE TENDIDO DEL CONDUCTOR

Conductor	Temp	Vano	Tensión	Tiro	Flecha	T 5 ondas	T10 ondas
IAL/Ac 95/15 -5 28 8,09 877,60 0,04 1,86 3,72							
IAL/Ac 95/15 -4 28 7,86 862,16 0,04 1,88 3,76							
IAL/Ac 95/15 -3 28 7,72 846,73 0,04 1,89 3,79							
IAL/Ac 95/15 -2 28 7,59 831,31 0,04 1,91 3,82							
IAL/Ac 95/15 -1 28 7,44 815,91 0,05 1,93 3,86							
IAL/Ac 95/15 0 28 7,30 800,51 0,05 1,95 3,90							
IAL/Ac 95/15 1 28 7,16 785,13 0,05 1,97 3,94							
IAL/Ac 95/15 2 28 7,02 769,77 0,05 1,99 3,97							
IAL/Ac 95/15 3 28 6,89 754,42 0,05 2,01 4,01							
IAL/Ac 95/15 4 28 6,74 739,09 0,05 2,03 4,06							
IAL/Ac 95/15 5 28 6,60 723,77 0,05 2,05 4,10							
IAL/Ac 95/15 6 28 6,46 708,48 0,05 2,07 4,14							
IAL/Ac 95/15 7 28 6,32 693,21 0,05 2,09 4,19							
IAL/Ac 95/15 8 28 6,18 677,96 0,06 2,12 4,23							
IAL/Ac 95/15 9 28 6,04 662,73 0,06 2,14 4,28							
IAL/Ac 95/15 10 28 5,90 647,54 0,06 2,17 4,33							
IAL/Ac 95/15 11 28 5,76 632,37 0,06 2,19 4,38							
IAL/Ac 95/15 12 28 5,63 617,24 0,06 2,22 4,44							
IAL/Ac 95/15 13 28 5,49 602,15 0,06 2,25 4,49							
IAL/Ac 95/15 14 28 5,35 587,09 0,06 2,28 4,55							
IAL/Ac 95/15 15 28 5,21 572,08 0,07 2,30 4,61							
IAL/Ac 95/15 16 28 5,09 557,12 0,07 2,34 4,67							
IAL/Ac 95/15 17 28 4,94 542,21 0,07 2,37 4,74							
IAL/Ac 95/15 18 28 4,81 527,36 0,07 2,40 4,80							
IAL/Ac 95/15 19 28 4,67 512,58 0,07 2,44 4,87							
IAL/Ac 95/15 20 28 4,54 497,86 0,07 2,47 4,94							
IAL/Ac 95/15 21 28 4,40 483,23 0,08 2,53 5,02							
IAL/Ac 95/15 22 28 4,27 468,68 0,08 2,55 5,09							
IAL/Ac 95/15 23 28 4,14 454,23 0,08 2,59 5,17							
IAL/Ac 95/15 24 28 4,03 439,88 0,08 2,63 5,26							
IAL/Ac 95/15 25 28 3,88 425,66 0,09 2,67 5,34							
IAL/Ac 95/15 26 28 3,75 411,57 0,09 2,72 5,44							
IAL/Ac 95/15 27 28 3,62 397,62 0,09 2,76 5,53							
IAL/Ac 95/15 28 28 3,50 383,84 0,10 2,81 5,63							
IAL/Ac 95/15 29 28 3,38 370,25 0,10 2,87 5,73							
IAL/Ac 95/15 30 28 3,25 356,85 0,10 2,92 5,84							
IAL/Ac 95/15 31 28 3,13 343,67 0,11 2,97 5,95							
IAL/Ac 95/15 32 28 3,03 330,74 0,11 3,03 6,06							
IAL/Ac 95/15 33 28 2,90 318,08 0,12 3,09 6,18							
IAL/Ac 95/15 34 28 2,79 305,71 0,12 3,15 6,31							
IAL/Ac 95/15 35 28 2,69 293,67 0,13 3,22 6,43							
IAL/Ac 95/15 36 28 2,57 281,96 0,13 3,28 6,57							
IAL/Ac 95/15 37 28 2,47 270,63 0,14 3,35 6,70							
IAL/Ac 95/15 38 28 2,37 259,70 0,14 3,42 6,84							
IAL/Ac 95/15 39 28 2,27 249,18 0,15 3,49 6,99							
IAL/Ac 95/15 40 28 2,19 239,09 0,16 3,57 7,13							
IAL/Ac 95/15 41 28 2,09 229,46 0,16 3,64 7,28							
IAL/Ac 95/15 42 28 2,01 220,28 0,17 3,71 7,43							
IAL/Ac 95/15 43 28 1,93 211,57 0,18 3,79 7,58							
IAL/Ac 95/15 44 28 1,85 203,33 0,18 3,87 7,73							
IAL/Ac 95/15 45 28 1,78 195,55 0,19 3,94 7,89							
IAL/Ac 95/15 46 28 1,72 188,22 0,20 4,02 8,04							
IAL/Ac 95/15 47 28 1,65 181,33 0,21 4,09 8,19							
IAL/Ac 95/15 48 28 1,59 174,86 0,21 4,17 8,34							
IAL/Ac 95/15 49 28 1,54 168,79 0,22 4,24 8,49							
IAL/Ac 95/15 50 28 1,49 163,11 0,23 4,32 8,63							

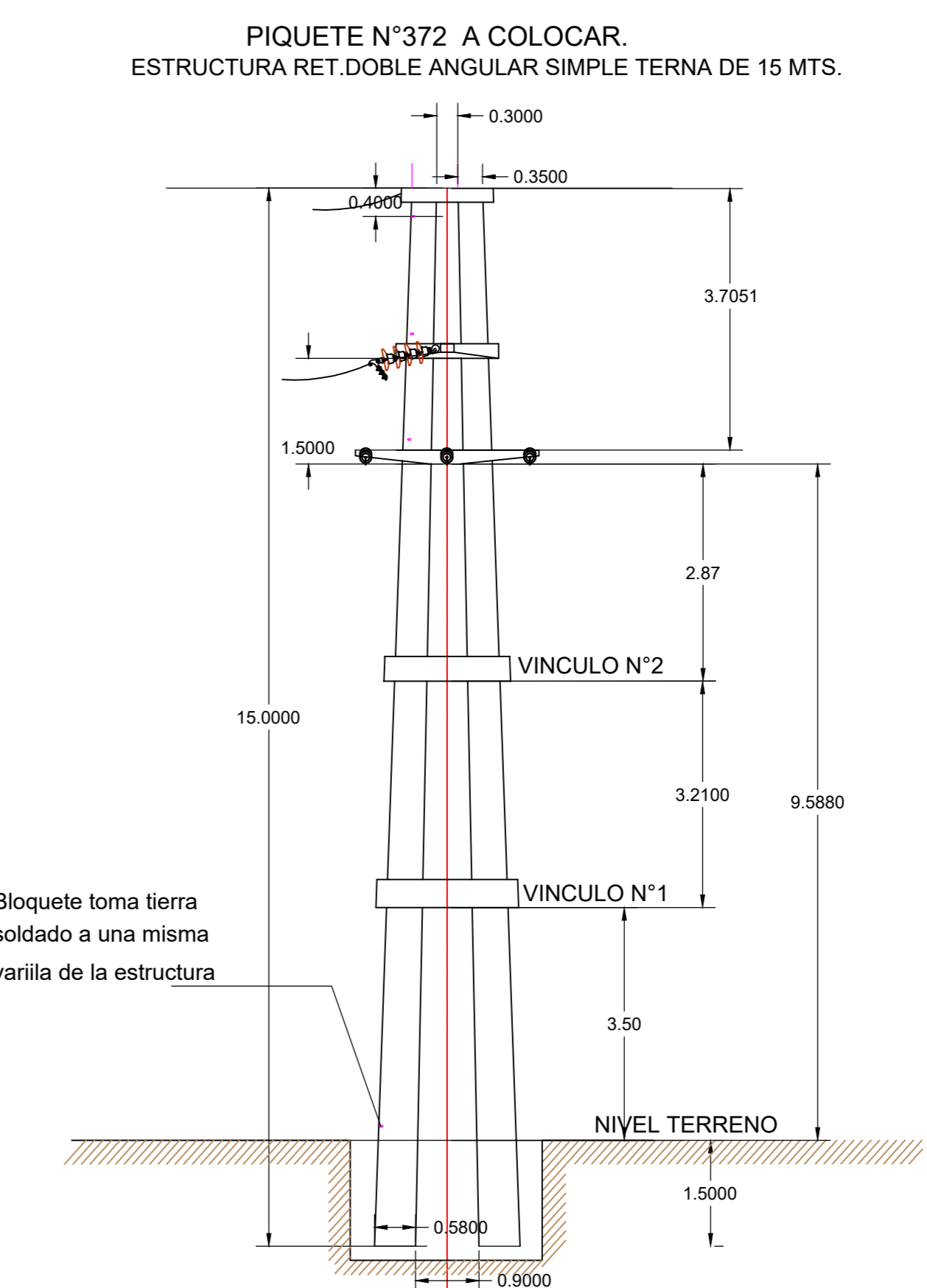
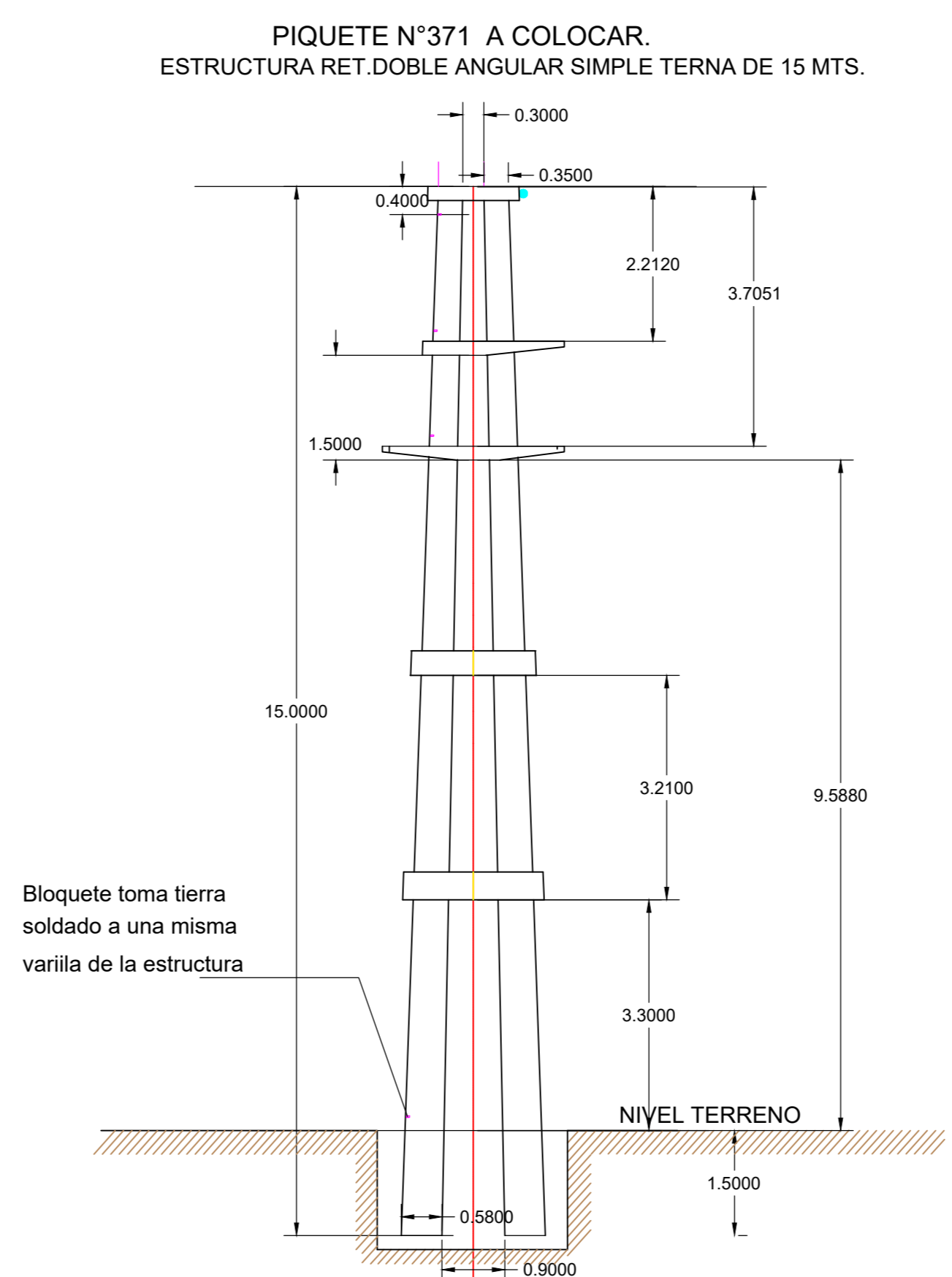
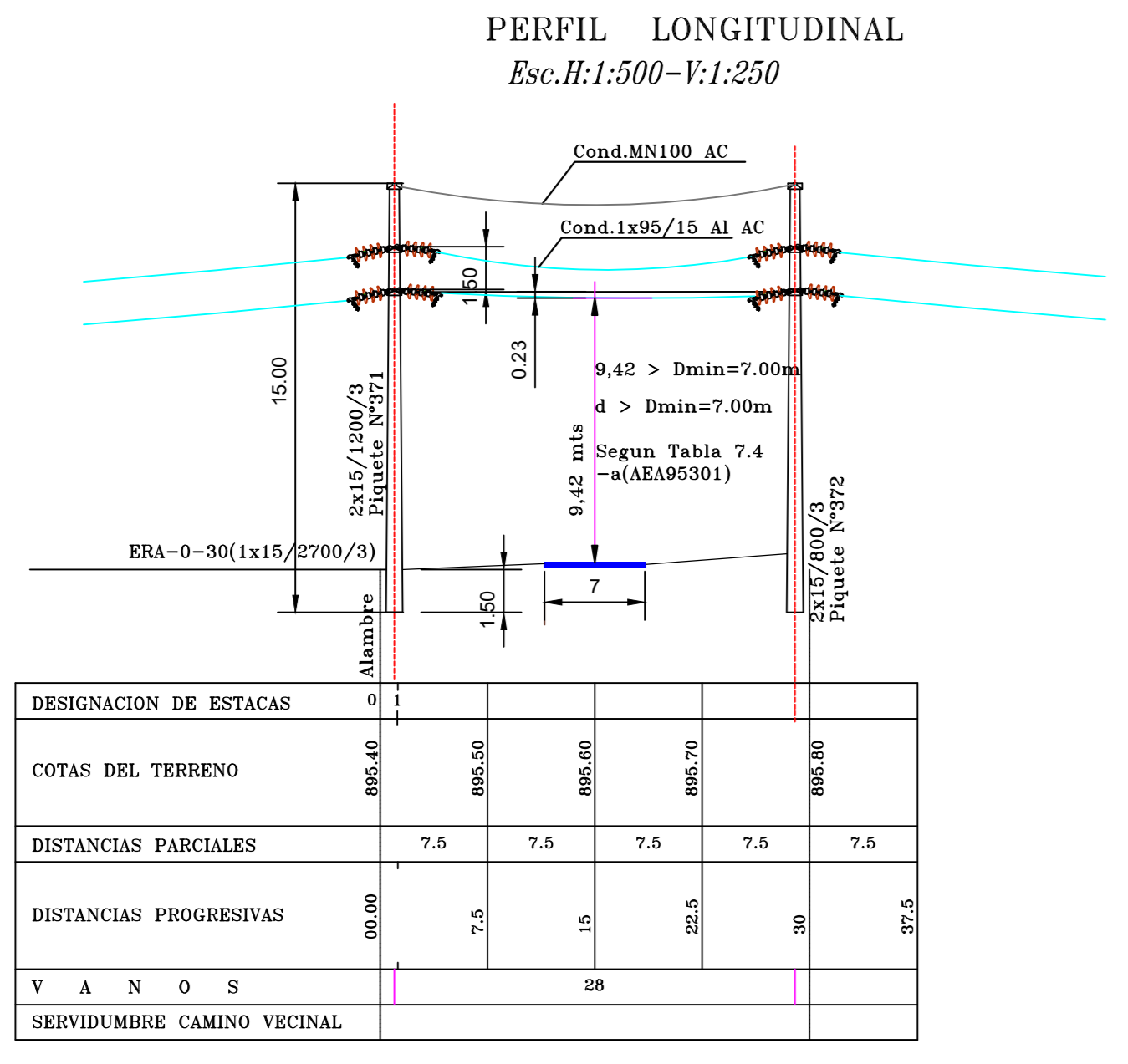



La altura o espesor del primer vínculo, numerando desde la cima hacia la base, será igual al diámetro del poste en la cima más 50 mm. Los siguientes vínculos aumentarán su espesor de 50 en 50 mm.

DIU (EDESA) PROYECTO DIU 108/17	PREVISADO (EDESA)	INSPECCIÓN DE OBRA (EDESA)
PROYECTO:	DIRECCIÓN DE OBRA:	
COPAIPA - LEY 4591 - HABILITACIÓN PROFESIONAL:	COPAIPA - LEY 7469 - VERIFICACIÓN	
	GERENCIA DE PROYECTOS, OBRAS Y N.S.S.	CONTRATISTA:
OBRA: TENDIDO DE LINEA DE MEDIA TENSION 33 KV CON HILO DE GUARDA DESDE E.T. 132 KV ROSARIO DE LA FRONTERA- PARQUE INDUSTRIAL- ACCESO A LOCALIDAD DE EL TALA.	REEMPLAZA A:	REEMPLAZADO POR:
FECHA: NOV 2021	ARCHIVO:	PROYECTO BASE DE BUN PROYECTO CON L.M.T.33 KV
ESCALAS: Ver Plano	CRUCE DE RUTA PROV.N°35 CON L.M.T.33 KV - 5	

1 2 56 3 4

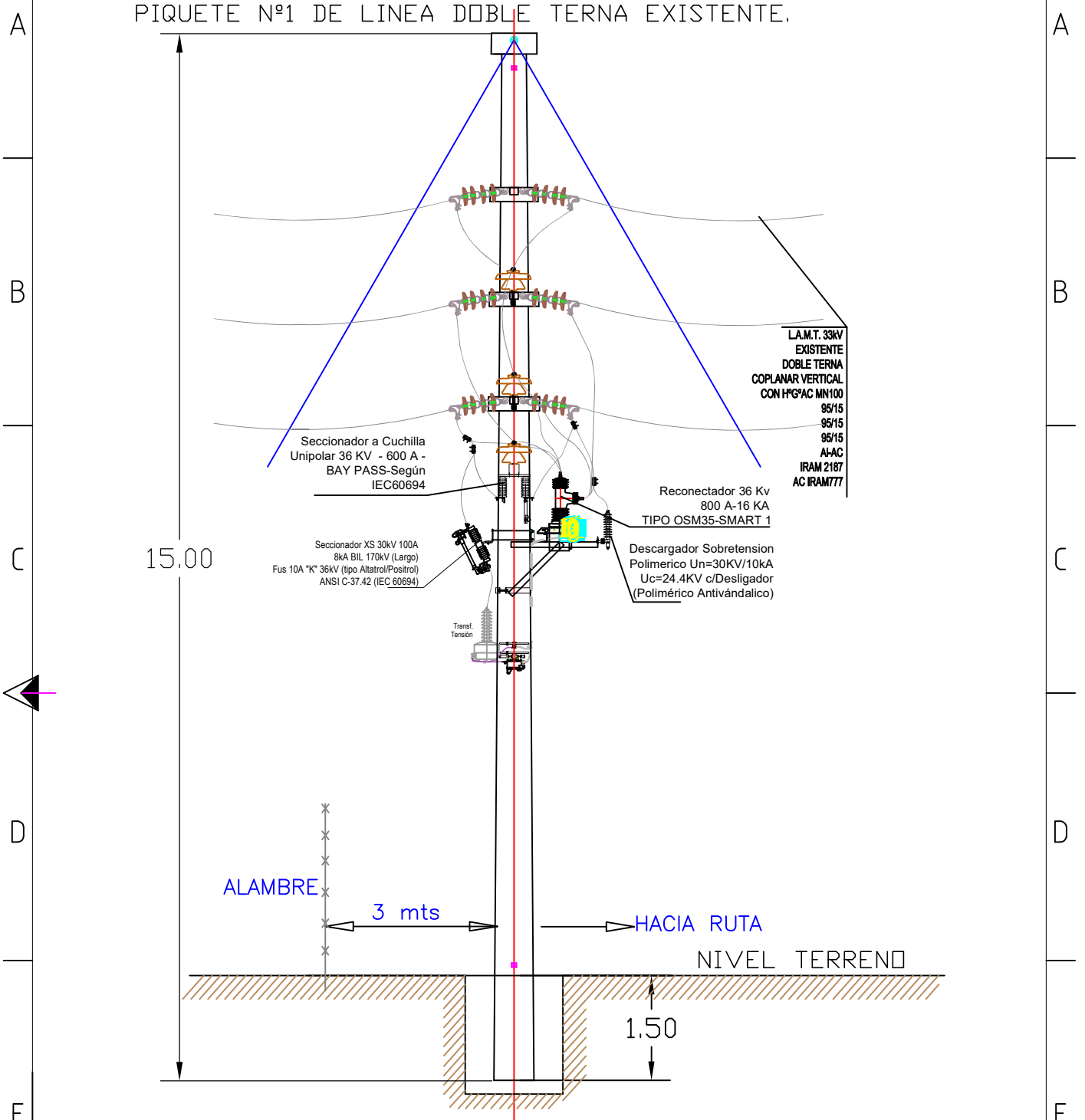
INSTALAR UN RECONECTADOR SOBRE ESTRUCTURA EXISTENTE
 FRENTE A E.T. ROSARIO DE LA FRONTERA.
 PIQUETE N°1 DE LINEA DOBLE TERNA EXISTENTE.



REV/CANT		DESCRIPCION	SEPT.2021	DIBUJO	CONTROLO
4		 INGENIERIA Y OBRAS	CONTRATISTA:		
DIBUJO			REEMPLAZA A:		
PROYECTO		ESTRUCTURA DE RETENCION ANGULAR SIMPLE TERNA TRIANGULAR 33 KV CONDUCTOR AL AC 95/15 mm ² +H°G°	REEMPLAZADO POR:		
CONTROLO			ARCHIVO:Estruc.de Ret.Angular S.T..dwg		
APROBO					
FECHA	SEPT.2021				
ESCALA	S/E				



República Argentina - Poder Ejecutivo Nacional
Las Malvinas son argentinas

Hoja Adicional de Firmas
Informe gráfico

Número:

Referencia: 03 - TALA - Planos 2

El documento fue importado por el sistema GEDO con un total de 20 pagina/s.